



**00S4**



Swaged Ferrule (skive)

127

**00Y4**



Swaged Ferrule (skive)

127

**00Y6**



Swaged Ferrule (skive)

128



**0050W**



BSP Female 60° cone Thrust Wire

128



**0350W**



BSP Male Parallel 60° cone

129



**0370W**



NPTF Male 60° cone

129

**0370Y**



NPTF Male 60° cone

130

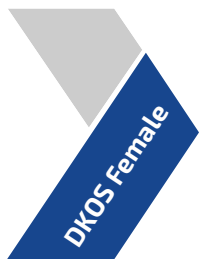

**0084W**



Metric Female 24° Seat Heavy

130

**0084Y**



Metric Female 24° Seat Heavy

131

# 00S4

## Swaged Ferrule (skive)

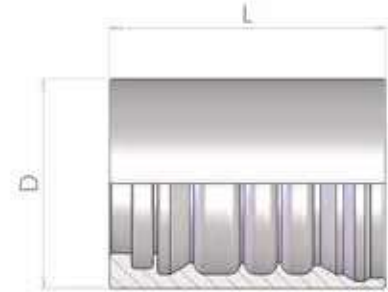

Part number	Hose I.D.		Dimensions	
			D	L
	in	mm		
00S4-06	3/8	9.5	28	455
00S4-08	1/2	12.7	33	503
00S4-12	3/4	19	41	56
00S4-16	1	25.4	51	672

# 00Y4

## Swaged Ferrule (skive)

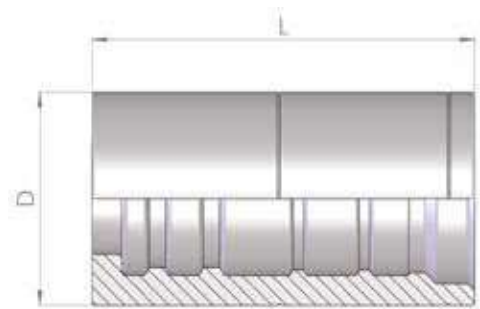

Part number	Hose I.D.		Dimensions	
			D	L
	in	mm		
00Y4-06	3/8	9.5	325	585
00Y4-08	1/2	12.7	365	62
00Y4-12	3/4	19	438	69

# 00Y6

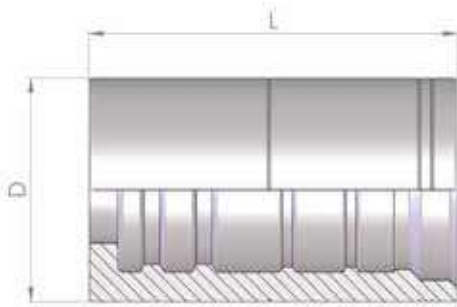

## Swaged Ferrule (skive)

Part number	Hose I.D.		Dimensions	
	in	mm	D	L
00Y6-06	3/8	9.5	355	585
00Y6-08	1/2	12.7	398	62
00Y6-12	3/4	19	47	69

# 0050W

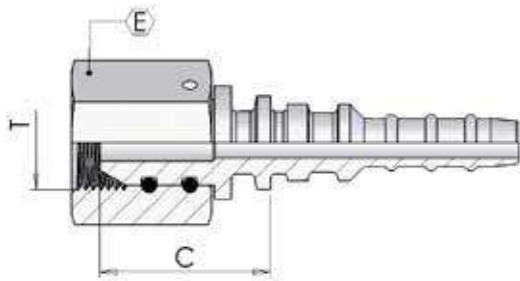

## BSP Female 60° cone Thrust Wire

Part number	Hose I.D.	Dimensions		
		dash size	Hex E	Cut-Off C
0050W08-08	1/2	08	30	33
0050W12-12	3/4	12	32	37
0050W16-16	1	16	38	40

# 0350W

## BSP Male Parallel 60° cone

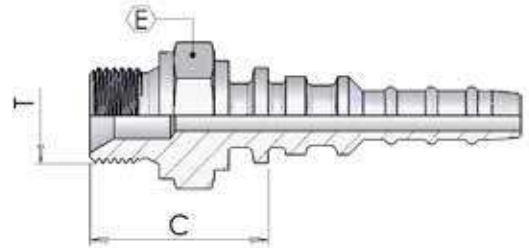

Part number	Hose I.D.		Dimensions			
			dash	Thread	Cut-Off	Hex
	in	mm	size	T	C	E
0350W08-08	1/2	12.7	08	1/2-14	36	27
0350W12-12	3/4	19	12	3/4-14	39	32

# 0370W

## NPTF Male 60° cone

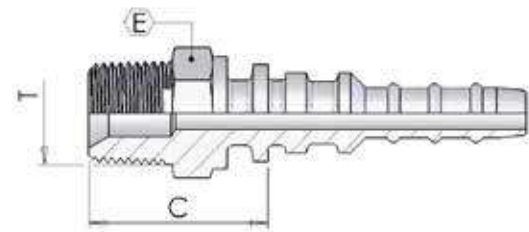

Part number	Hose I.D.		Dimensions			
			dash	Thread	Cut-Off	Hex
	in	mm	size	T	C	E
0370W06-06	3/8	9.5	06	3/8-18	30	19
0370W08-08	1/2	12.7	08	1/2-14	39	22
0370W12-12	3/4	19	12	3/4-14	40	27
0370W16-16	1	25.4	16	1-11.1/2	49	38

# 0370Y

## NPTF Male 60° cone

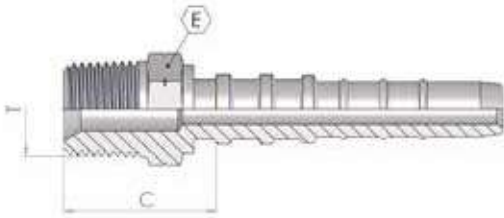

Part number	Hose I.D.		Dimensions			
			dash	Thread	Cut-Off	Hex
	in	mm	size	T	C	E
0370Y06-06	3/8	9.5	06	3/8-18	29	19
0370Y08-08	1/2	12.7	08	1/2-14	35	22
0370Y12-12	3/4	19	12	3/4-14	37	27

# 0084W

## Metric Female 24° Seat Heavy

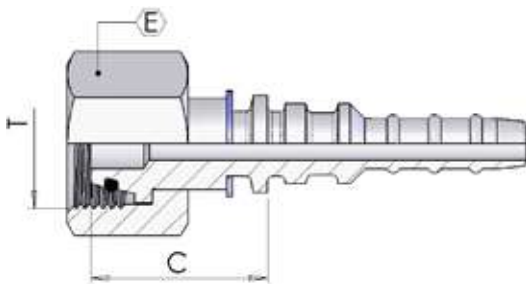

Part number	Hose I.D.		Dimensions				
			dash	Thread		Cut-Off	Hex
	in	mm	size	T	Erm	C	E
0084W06-20	3/8	9.5	06	M20-1.5	12	29	24
0084W06-22	3/8	9.5	06	M22-1.5	14	31	27
0084W06-24	3/8	9.5	06	M24-1.5	16	31	30
0084W08-24	1/2	12.7	08	M24-1.5	16	33	30
0084W12-36	3/4	19	12	M36-2	25	43	46

# 0084Y

## Metric Female 24° Seat Heavy

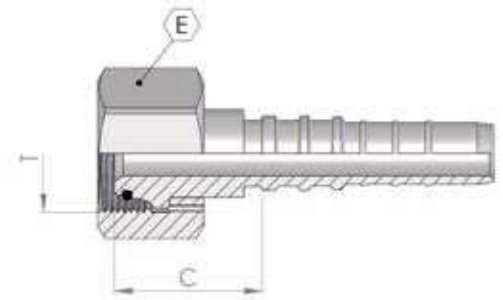

Part number	Hose I.D.		Dimensions				
			dash	Thread		Cut-Off	Hex
	in	mm	size	T	Erm	C	E
0084Y06-24	3/8	9.5	06	M24-1.5	16	39	32
0084Y08-24	1/2	12.7	08	M24-1.5	16	39	34
0084Y12-36	3/4	19	12	M36-2	25	45	46