



0370G



NPTF Male 60° Cone

6

037GG



NPTF Male Parallel
60° Cone Rotating

7

N051G



NPSM Female 60°
Cone Rolled Nut

7



0850G



JIC Male 74° Cone

8

0911G



JIC Female 74° Cone
Rolled Nut

9

0910G

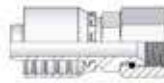

JIC Female 74° Cone
Thrust Wire Nut

10

1001G



JIC 90° Swept Elbow
74° Cone Rolled Nut

10

1000G



JIC 45° Swept Elbow
74° Cone Slipse on nut

11

0951G



JIC 90° Swept Elbow
74° Cone Rolled Nut

11

0950G



JIC 90° Swept Elbow
74° Cone Thrust Wire
Nut

12

2971G



JIC 90° Compact
Elbow 74° Cone
Crimped Nut

12



S350G



ORFS Male

13

S05TG



ORFS Female Back
Hexagon

13

S250G



ORFS 45° Swept
Elbow

14

S150G



ORFS 90° Swept
Elbow

15



0385G



SAE Male O'R Flat
Seat

16

0390G



Swivel Male O'Ring

16

0395G



90° Swivel Male O'ring

17



IF00G



Straight Male Inverted
Flare Swivel

17

IF45G



45° Male Inverted
Flare Swivel

18

IF90G



90° Male Inverted Flare Swivel

18



0930G



JIS Female 60° Cone (Toyota)

19

0980G



90° JIS Swept Elbow (Toyota) - welded

19



0940G



JIS Female 60° Cone (Komatsu)

20

1040G



45° JIS Swept Elbow (Komatsu) Welded

20

0990G



90° JIS Swept Elbow (Komatsu) Welded

21



K05BG



Kobelco Male

21



0360G



BSP Taper Male 60° Cone

22

0350G



BSP Male Parallel 60° Cone

23

0051G



BSP Female 60° Cone Rolled Nut

24

0050G



BSP Female 60° Cone Thrust wire Nut

24

0251G



BSP 45° Swept Elbow 60° Cone Rolled nut

25

0250G



BSP 45° Swept Elbow 60° Cone Thrust Wire Nut

25

0151G



BSP 90° Swept elbow 60° Cone Rolled Nut

26

0150G



BSP 90° Swept Elbow 60° Cone Thrust Wire

26

0041G



BSP O'Ring Female 60° Cone Rolled Nut

27

0241G



BSP O'Ring 45° Swept Elbow 60° Cone Rolled nut

27

0141G



BSP O'Ring 90° Swept elbow 60° Cone Rolled Nut

28

2321G



BSP 90° Compact Elbow 60° Cone Rolled nut

28



0060G



BSP Female Flat Seal

29

<p>BSP Banjo/ bolt</p>	<p>1400G</p> <p>BSP Banjo</p> <p>30</p>	<p>1600-00</p> <p>BSP perfored bolt</p> <p>31</p>	<p>1600</p> <p>Double BSP perfored bolt</p> <p>31</p>	<p>BSP Flat-1</p>
-----------------------------------	--	--	--	--------------------------

<p>FK50G</p> <p>K' Female</p> <p>32</p>	<p>Metric Standpipe</p>	<p>0550G</p> <p>Metric Standpipe</p> <p>33</p>	<p>0750G</p> <p>45° Metric Standpipe</p> <p>34</p>	<p>0750G</p> <p>45° Metric Standpipe (Welded)</p> <p>35</p>
--	--------------------------------	---	---	--

<p>0650G</p> <p>90° Metric Standpipe</p> <p>36</p>	<p>0650G</p> <p>90° Metric Standpipe (welded)</p> <p>37</p>	<p>Metric Banjo/ bolt</p>	<p>1350G</p> <p>Metric Banjo</p> <p>38</p>	<p>1650</p> <p>Metric perfored bolt</p> <p>39</p>
---	--	--------------------------------------	---	--

<p>Metric Din 24° DKOL</p>	<p>0500G</p> <p>Metric Male 24° Seat Light</p> <p>40</p>	<p>0085G</p> <p>Metric Female 24° Seat Light</p> <p>41</p>	<p>0085G</p> <p>Metric Female 24° Seat Light (rolled nut)</p> <p>41</p>	<p>0285G</p> <p>45° Metric Swept Elbow 24° Seat Light</p> <p>42</p>
---------------------------------------	---	---	--	--

<p>0285G</p> <p>45° Metric Swept Elbow 24° Seat Light (rolled nut)</p> <p>42</p>	<p>0185G</p> <p>90° Metric Swept Elbow 24° Seat Light</p> <p>43</p>	<p>0185G</p> <p>90° Metric Swept Elbow 24° Seat Light (rolled nut)</p> <p>43</p>	<p>Metric Din 24° DKOS</p>	<p>0450G</p> <p>Metric Male 24° Seat Heavy</p> <p>44</p>
---	--	---	---------------------------------------	---

Dimensions and general characteristics may be changed at any time, data contained here in are only for information purpose only and it does not enlarge, amend or imply any warranty other than provided by us with the product. Any use of the product not in conformance with our instructions may be dangerous.

0084G



Metric Female 24°
Seat Heavy

45

0284G



45° Metric Swept
Elbow 24° Seat Heavy

46

0184G



90° Metric Swept
Elbow 24° Seat Heavy

47



1260G



Straight SAE Flange
3000 PSI

48

1160G



45° SAE Flange 3000
PSI

48

1060G



90° SAE Flange 3000
PSI

49

1060G



22.5°/30°/60°/67.5°
SAE Flange 3000 PSI

50



D050G



Hose Junction

51

0370G

NPTF Male 60° Cone

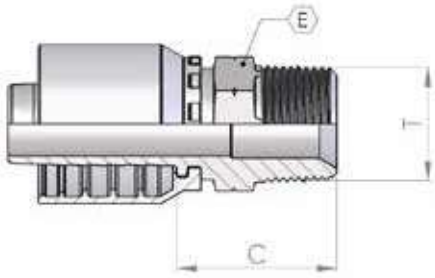

Part number	Hose I.D.		Dimension			
	in	mm	dash size	thread	hex	cut-off
				T	E	C
0370G03-02	3/16	4.8	3	1/8-27	12	22
0370G03-04	3/16	4.8	3	1/4-18	15	27
0370G04-02	1/4	6.4	4	1/8-27	12	22
0370G04-04	1/4	6.4	4	1/4-18	15	28
0370G04-06	1/4	6.4	4	3/8-18	19	28
0370G05-04	5/16	7.9	5	1/4-18	15	28
0370G05-06	5/16	7.9	5	3/8-18	19	28
0370G05-08	5/16	7.9	5	1/2-14	22	34
0370G06-04	3/8	9.5	6	1/4-18	17	28
0370G06-06	3/8	9.5	6	3/8-18	19	28
0370G06-08	3/8	9.5	6	1/2-14	22	34
0370G08-06	1/2	12.7	8	3/8-18	19	29
0370G08-08	1/2	12.7	8	1/2-14	22	35
0370G08-12	1/2	12.7	8	3/4-14	27	36
0370G10-08	5/8	15.9	10	1/2-14	24	35
0370G10-12	5/8	15.9	10	3/4-14	27	36
0370G12-08	3/4	19.0	12	1/2-14	24	36
0370G12-12	3/4	19.0	12	3/4-14	27	37
0370G12-16	3/4	19.0	12	1-11.1/2	36	43
0370G16-16	1	25.4	16	1-11.1/2	36	44
0370G16-20	1	25.4	16	1.1/4-11.1/2	46	46
0370G20-16	1.1/4	31.8	20	1-11.1/2	41	45
0370G20-20	1.1/4	31.8	20	1.1/4-11.1/2	46	47
0370G24-24	1.1/2	38.1	24	1.1/2-11.1/2	50	49
0370G32-32	2	50.8	32	2-11.1/2	65	55

037GG

NPTF Male Parallel 60° Cone - Rotating

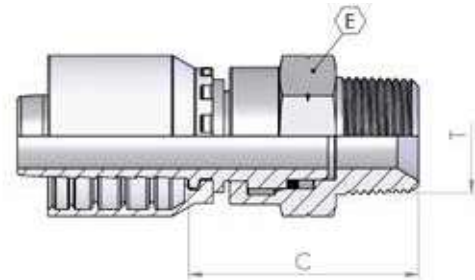

Part number	Hose I.D.		Dimension			
	in	mm	dash size	thread	hex	cut-off
				T	E	C
037GG04-04	1/4	6.4	4	1/4-18	19	39
037GG06-06	3/8	9.5	6	3/8-18	22	43
037GG08-08	1/2	12.7	8	1/2-14	27	49
037GG12-12	3/4	19.0	12	3/4-14	32	52

N051G

NPSM Female 60° Cone Rolled Nut

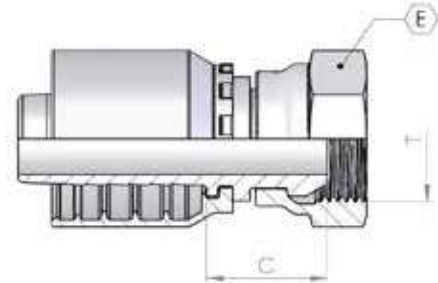

Part number	Hose I.D.		Dimension			
	in	mm	dash size	thread	hex	cut-off
				T	E	C
N051G03-04	3/16	4.8	3	1/4-18	19	17
N051G04-04	1/4	6.4	4	1/4-18	19	17
N051G06-06	3/8	9.5	6	3/8-18	22	19
N051G08-08	1/2	12.7	8	1/2-14	27	23

0850G

JIC Male 74° Cone

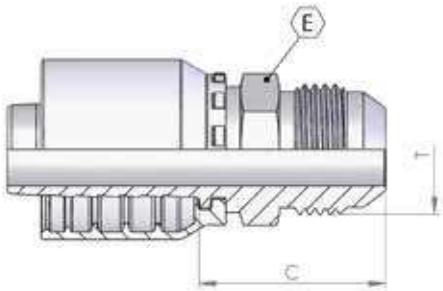

* SAE 45°

Part number	Hose I.D.		Dimension			
	in	mm	dash size	thread	hex	cut-off
				T	E	C
0850G03-04	3/16	4.8	3	7/16-20	12	26
0850G04-04	1/4	6.4	4	7/16-20	12	27
0850G04-05	1/4	6.4	4	1/2-20	14	27
0850G04-06	1/4	6.4	4	9/16-18	15	27
0850G05-05	5/16	7.9	5	1/2-20	14	27
0850G05-06	5/16	7.9	5	9/16-18	15	27
0850G05-08	5/16	7.9	5	3/4-16	19	30
0850G06-06	3/8	9.5	6	9/16-18	15	27
* SAE 45° 0850G06-07	3/8	9.5	6	5/8-18	17	30
0850G06-08	3/8	9.5	6	3/4-16	19	30
0850G06-10	3/8	9.5	6	7/8-14	24	34
0850G08-06	1/2	12.7	8	9/16-18	19	28
0850G08-08	1/2	12.7	8	3/4-16	19	31
0850G08-10	1/2	12.7	8	7/8-14	24	35
0850G08-12	1/2	12.7	8	1.1/16-12	27	37
0850G10-10	5/8	15.9	10	7/8-14	24	35
0850G10-12	5/8	15.9	10	1.1/16-12	27	37
0850G12-10	3/4	19.0	12	7/8-14	24	36
0850G12-12	3/4	19.0	12	1.1/16-12	27	38
0850G12-14	3/4	19.0	12	1.3/16-12	32	41
0850G12-16	3/4	19.0	12	1.5/16-12	34	42
0850G12-20	3/4	19.0	12	1.5/8-12	42	45
0850G16-12	1	25.4	16	1.1/16-12	27	39
0850G16-14	1	25.4	16	1.3/16-12	32	42
0850G16-16	1	25.4	16	1.5/16-12	34	43
0850G16-20	1	25.4	16	1.5/8-12	42	46
0850G20-20	1.1/4	31.8	20	1.5/8-12	42	47
0850G20-24	1.1/4	31.8	20	1.7/8-12	50	52
0850G24-24	1.1/2	38.1	24	1.7/8-12	50	52
0850G32-32	2	50.8	32	2.1/2-12	65	62

0911G

JIC Female 74° Cone - Rolled Nut

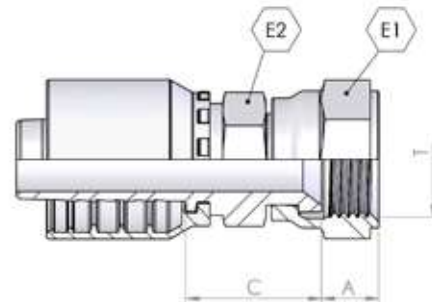

Part number	Hose I.D.		Dimension				
	in	mm	dash size	thread	hex	cut-off	
				T	E	C	A
0911G03-04	3/16	4.8	3	7/16-20	15	14	8.5
0911G03-05	3/16	4.8	3	1/2-20	17	14	9.5
0911G04-04	1/4	6.4	4	7/16-20	15	14	8.5
0911G04-05	1/4	6.4	4	1/2-20	17	15	9.5
0911G04-06	1/4	6.4	4	9/16-18	19	16	9
*SAE 45° 0911G04-07	1/4	6.4	4	5/8-18	22	17	11
0911G05-05	5/16	7.9	5	1/2-20	17	17	9.5
0911G05-06	5/16	7.9	5	9/16-18	19	16	9
*SAE 45° 0911G05-07	5/16	7.9	5	5/8-18	22	17	11
0911G05-08	5/16	7.9	5	3/4-16	24	17	10.5
0911G06-04	3/8	9.5	6	7/16-20	15	15	9
0911G06-05	3/8	9.5	6	1/2-20	17	15	9.5
0911G06-06	3/8	9.5	6	9/16-18	19	16	9
*SAE 45° 0911G06-07	3/8	9.5	6	5/8-18	22	16	11
0911G06-08	3/8	9.5	6	3/4-16	24	17	10.5
0911G06-10	3/8	9.5	6	7/8-14	27	21	13
0911G08-08	1/2	12.7	8	3/4-16	24	18	10.5
0911G08-10	1/2	12.7	8	7/8-14	27	19	13
0911G08-12	1/2	12.7	8	1.1/16-12	32	24	13.5
0911G10-10	5/8	15.9	10	7/8-14	27	19	13
0911G10-12	5/8	15.9	10	1.1/16-12	32	21	13.5
0911G12-10	3/4	19.0	12	7/8-14	27	20	13
0911G12-12	3/4	19.0	12	1.1/16-12	32	22	13.5
0911G12-14	3/4	19.0	12	1.3/16-12	36	23	14
0911G12-16	3/4	19.0	12	1.5/16-12	38	23	15.5
0911G16-12	1	25.4	16	1.1/16-12	32	23	13.5
0911G16-16	1	25.4	16	1.5/16-12	38	24	15.5

0910G

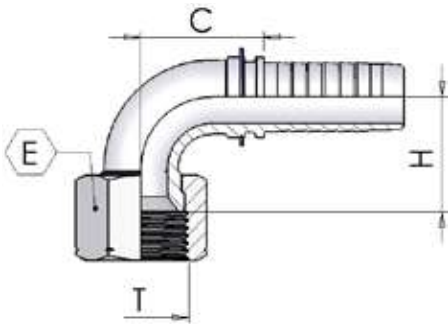

JIC Female 74° Cone - Thrust Wire Nut

Part number	Hose I.D.		Dimension					
	in	mm	dash size	thread	hex		cut-off	
				T	E1	E2	C	A
0910G20-20	1.1/4	31.8	20	1.5/8"-12	50	46	39	16
0910G24-24	1.1/2	38.1	24	1.7/8"-12	55	50	41	18
0910G32-32	2	50.8	32	2.1/2"-12	70	65	61	19

1001G

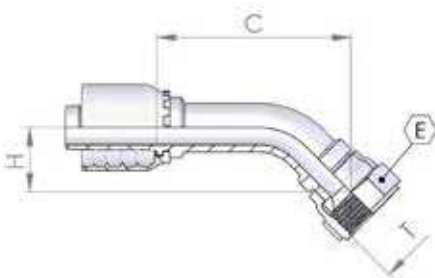

JIC 90° Swept Elbow 74° Cone - Rolled Nut

Part number	Hose I.D.		Dimension					
	in	mm	dash size	thread	hex	cut-off	Drop	
				T	E	C	H	
1001G03-04	3/16	4.8	3	7/16-20	15	33	15	
1001G04-04	1/4	6.4	4	7/16-20	15	38	13	
1001G04-05	1/4	6.4	4	1/2-20	17	40	14	
1001G04-06	1/4	6.4	4	9/16-18	19	47	18	
1001G05-05	5/16	7.9	5	1/2-20	17	16	17	
1001G05-06	5/16	7.9	5	9/16-18	19	47	18	
1001G06-05	3/8	9.5	6	1/2-20	17	51	17	
1001G06-06	3/8	9.5	6	9/16-18	19	51	17	
*SAE 45°	1001G06-07	3/8	9.5	6	5/8-18	22	51	17
	1001G06-08	3/8	9.5	6	3/4-16	24	52	19
	1001G06-10	3/8	9.5	6	7/8-14	27	54	21
	1001G08-08	1/2	12.7	8	3/4-16	24	62	22
	1001G08-10	1/2	12.7	8	7/8-14	27	64	23
	1001G08-12	1/2	12.7	8	1.1/16-12	32	68	25
	1001G10-10	5/8	15.9	10	7/8-14	27	68	24
	1001G10-12	5/8	15.9	10	1.1/16-12	32	70	25
WELDED	1001G12-10	3/4	19	12	7/8-14	27	83	27
	1001G12-12	3/4	19	12	1.1/16-12	32	84	28
	1001G12-16	3/4	19	12	1.5/16-12	38	88	30
	1001G16-16	1	25.4	16	1.5/16-12	38	104	33

1000G

JIC 45° Swept Elbow 74° Cone - Slip on nut

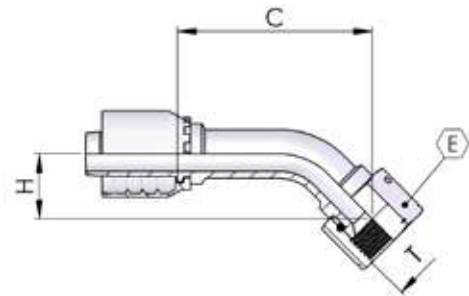

Part number	Hose I.D.		Dimension				
	in	mm	dash size	thread	hex	cut-off	Drop
				T	E	C	H
1000G20-20	1.1/4	31.8	20	1.5/8"-12	50	102	40
1000G24-24	1.1/2	38.1	24	1.7/8"-12	55	119	49
1000G32-32	2	50.8	32	2.1/2"-12	70	142	65

0951G

JIC 90° Swept Elbow 74° Cone - Rolled Nut

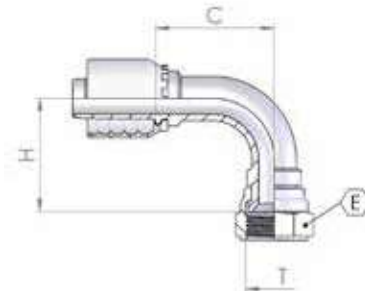

Part number	Hose I.D.		Dimension				
	in	mm	dash size	thread	hex	cut-off	Drop
				T	E	C	H
0951G03-04	3/16	4.8	3	7/16-20	15	22	22
0951G03-05	3/16	4.8	3	1/2-20	17	22	22
0951G04-04	1/4	6.4	4	7/16-20	15	25	24
0951G04-05	1/4	6.4	4	1/2-20	17	25	25
0951G04-06	1/4	6.4	4	9/16-18	19	25	27
0951G05-05	5/16	7.9	5	1/2-20	17	29	30
0951G05-06	5/16	7.9	5	9/16-18	19	29	31
0951G06-05	3/8	9.5	6	1/2-20	17	33	30
0951G06-06	3/8	9.5	6	9/16-18	19	31	32
*SAE 45° 0951G06-07	3/8	9.5	6	5/8-18	22	33	32
0951G06-08	3/8	9.5	6	3/4-16	24	33	34
0951G06-10	3/8	9.5	6	7/8-14	27	33	36
0951G08-08	1/2	12.7	8	3/4-16	24	41	41
0951G08-10	1/2	12.7	8	7/8-14	27	41	40
0951G08-12	1/2	12.7	8	1.1/16-12	32	39	43
0951G10-10	5/8	15.9	10	7/8-14	27	43	44
WELDED 0951G12-10	3/4	19	12	7/8-14	27	56	53
0951G12-12	3/4	19	12	1.1/16-12	32	56	54
0951G12-14	3/4	19	12	1.3/16-12	36	57	53
0951G12-16	3/4	19	12	1.5/16-12	38	55	56
0951G16-12	1	25.4	16	1.1/16-12	32	70	63
0951G16-16	1	25.4	16	1.5/16-12	38	70	65

0950G

JIC 90° Swept Elbow 74° Cone - Thrust Wire Nut

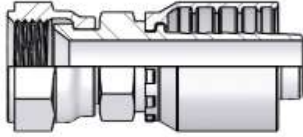

Part number	Hose I.D.		Dimension				
	in	mm	dash size	thread	hex	cut-off	Drop
				T	E	C	H
0950G20-20	1.1/4	31.8	20	1.5/8"-12	50	87	83
0950G24-24	1.1/2	38.1	24	1.7/8"-12	55	102	97
0950G32-32	2	50.8	32	2.1/2"-12	70	125	134

2971G

JIC 90° Compact Elbow 74° Cone - Crimped Nut

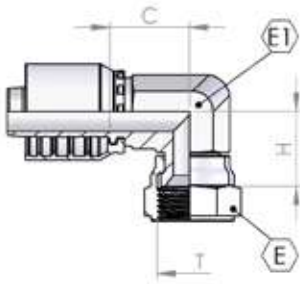

Part number	Hose I.D.		Dimension					
	in	mm	dash size	thread	hex		cut-off	Drop
				T	E	E1	C	H
2971G04-04	1/4	6.4	4	7/16-20	15	15	19	17
2971G04-05	1/4	6.4	4	1/2-20	17	15	19	18
2971G04-06	1/4	6.4	4	9/16-18	19	15	19	19
2971G05-06	5/16	7.9	5	9/16-18	19	17	20	20
2971G06-06	3/8	9.5	6	9/16-18	19	17	23	20
2971G06-08	3/8	9.5	6	3/4-16	24	22	24	22
2971G08-08	1/2	12.7	8	3/4-16	24	22	26	23
2971G08-10	1/2	12.7	8	7/8-14	27	22	26	24
2971G12-12	3/4	19	12	1.1/16-12	32	27	32	29
2971G16-16	1	25.4	16	1.5/16-12	38	32	38	34

S350G

ORFS Male

- with plug and O-Ring

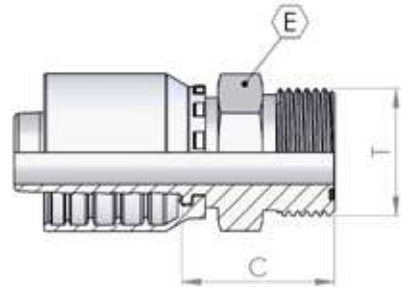

Part number	Hose I.D.		Dimension			
	in	mm	dash size	thread	hex	cut-off
				T	E	C
S350G04-06	1/4	6.4	4	9/16-18	17	23
S350G04-09	1/4	6.4	4	11/16-16	19	21
S350G05-09	5/16	7.9	5	11/16-16	19	26
S350G06-09	3/8	9.5	6	11/16-16	19	26
S350G06-11	3/8	9.5	6	13/16-16	22	29
S350G08-11	1/2	12.7	8	13/16-16	22	29
S350G08-13	1/2	12.7	8	1-14	27	34
S350G08-14	1/2	12.7	8	1.3/16-12	32	35
S350G10-13	5/8	15.9	10	1-14	27	33
S350G10-14	5/8	15.9	10	1.3/16-12	32	35
S350G12-14	3/4	19.0	12	1.3/16-12	32	36
S350G12-15	3/4	19.0	12	1.7/16-12	38	36
S350G16-15	1	25.4	16	1.7/16-12	38	37
S350G16-21	1	25.4	16	1.11/16-12	46	38
S350G20-21	1.1/4	31.8	20	1.11/16-12	46	39

S05TG

ORFS Female Back Hexagon

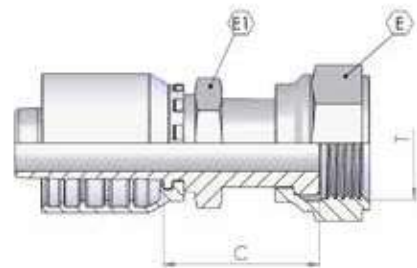

Part number	Hose I.D.		Dimension				
	in	mm	dash size	thread	hex		cut-off
				T	E	E1	C
S05TG04-06	1/4	6.4	4	9/16-18	17	15	30
S05TG06-09	3/8	9.5	6	11/16-16	22	17	34
S05TG08-11	1/2	12.7	8	13/16-16	24	19	37
S05TG10-13	5/8	15.9	10	1-14	30	24	41
S05TG12-14	3/4	19.0	12	1.3/16-12	36	30	42
S05TG16-15	1	25.4	16	1.7/16-12	41	36	50
S05TG-20-21	1.1/4	31.8	20	1.11/16-12	50	46	60
S05TG-24-32	1.1/2	38.1	24	2-12	60	50	68

S250G

ORFS 45° Swept Elbow

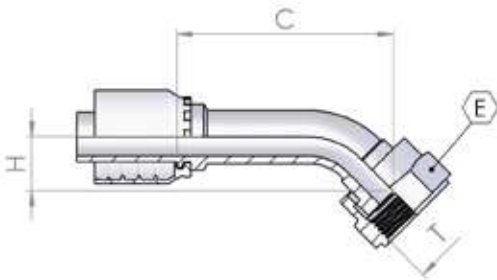

Part number	Hose I.D.		Dimension				
	in	mm	dash size	thread	hex	cut-off	Drop
				T	E	C	H
S250G04-06	1/4	6.4	4	9/16-18	19	40	14
S250G04-09	1/4	6.4	4	11/16-16	22	38	14
S250G05-09	5/16	7.9	5	11/16-16	22	44	14
S250G06-09	3/8	9.5	6	11/16-16	22	52	17
S250G06-11	3/8	9.5	6	13/16-16	24	51	18
S250G08-11	1/2	12.7	8	13/16-16	24	62	20
S250G08-13	1/2	12.7	8	1-14	30	64	23
S250G08-14	1/2	12.7	8	1.3/16-12	36	62	23
S250G10-13	5/8	15.9	10	1-14	30	67	22
WELDED S250G10-14	5/8	15.9	10	1.3/16-12	36	44	18
WELDED S250G12-13	3/4	19.0	12	1-14	30	40	15
S250G12-14	3/4	19.0	12	1.3/16-12	36	84	23
S250G12-15	3/4	19.0	12	1.7/16-12	41	84	26
S250G16-15	1	25.4	16	1.7/16-12	41	100	31
WELDED S250G20-21	1.1/4	31.8	20	1.11/16-12	50	125	44
WELDED S250G24-32	1.1/2	38.1	24	2-12	60	78	29

S150G

ORFS 90° Swept Elbow

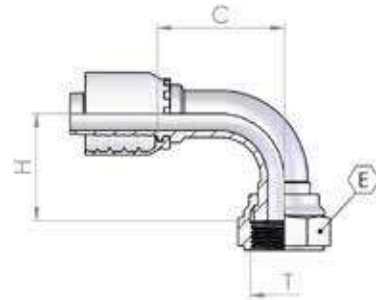

Part number	Hose I.D.		Dimension				
	in	mm	dash size	thread	hex	cut-off	Drop
				T	E	C	H
S150G04-06	1/4	6.4	4	9/16-18	19	25	26
S150G04-09	1/4	6.4	4	11/16-16	22	25	23
S150G05-09	5/16	7.9	5	11/16-16	22	29	32
S150G06-09	3/8	9.5	6	11/16-16	22	33	33
S150G06-11	3/8	9.5	6	13/16-16	24	33	32
S150G08-11	1/2	12.7	8	13/16-16	24	39	36
S150G08-13	1/2	12.7	8	1-14	30	39	40
S150G08-14	1/2	12.7	8	1.3/16-12	36	42	39
S150G10-13	5/8	15.9	10	1-14	30	47	39
WELDED S150G10-14	5/8	15.9	10	1.3/16-12	36	42	39
WELDED S150G12-13	3/4	19.0	12	1-14	30	42	39
S150G12-14	3/4	19.0	12	1.3/16-12	36	57	49
S150G12-15	3/4	19.0	12	1.7/16-12	41	56	51
S150G16-15	1	25.4	16	1.7/16-12	41	67	62
WELDED S150G16-21	1	25.4	20	1.11/16-12	50	62	58
WELDED S150G20-21	1.1/4	31.8	20	1.11/16-12	50	63	58
WELDED S150G24-32	1.1/2	38.1	24	2-12	60	80	73

0385G

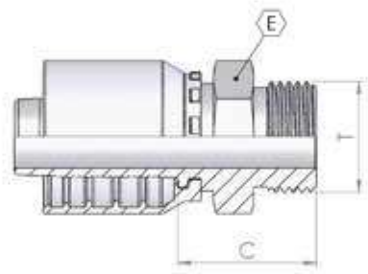

SAE Male O'R - Flat Seat

Part number	Hose I.D.		Dimension			
	in	mm	dash size	thread	hex	cut-off
				T	E	C
0385G04-04	1/4	6.4	4	7/16-20	14	24
0385G04-06	1/4	6.4	4	9/16-18	17	24
0385G05-06	5/16	7.9	5	9/16-18	17	24
0385G06-06	3/8	9.5	6	9/16-18	17	25
0385G06-08	3/8	9.5	6	3/4-16	22	28
0385G08-08	1/2	12.7	8	3/4-16	22	28
0385G08-10	1/2	12.7	8	7/8-14	27	30
0385G08-12	1/2	12.7	8	1.1/16-12	32	32
0385G10-10	5/8	15.9	10	7/8-14	27	30
0385G10-12	5/8	15.9	10	1.1/16-12	32	32
0385G12-12	3/4	19.0	12	1.1/16-12	32	33

0390G

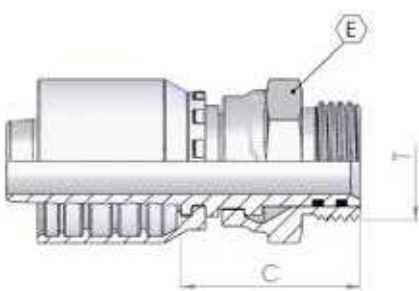

Swivel Male O'Ring

Part number	Hose I.D.		Dimension			
	in	mm	dash size	thread	hex	cut-off
				T	E	C
0390G08-10	1/2	12.7	8	7/8-14	27	39
0390G10-10	5/8	15.9	10	7/8-14	27	39
0390G12-12	3/4	19.0	12	1.1/16-12	32	43

0395G

90° Swivel Male O'ring

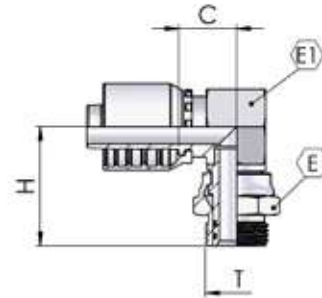

Part number	Hose I.D.		Dimension					
	in	mm	dash size	thread	hex		cut-off	Drop
				T	E	E1	C	H
0395G08-10	1/2	12.7	8	7/8-14	27	27	21	48
0395G10-10	5/8	15.9	10	7/8-14	27	27	21	48
0395G12-12	3/4	19.0	12	1.1/16-12	32	32	25	52

IF00G

Straight Male Inverted Flare Swivel

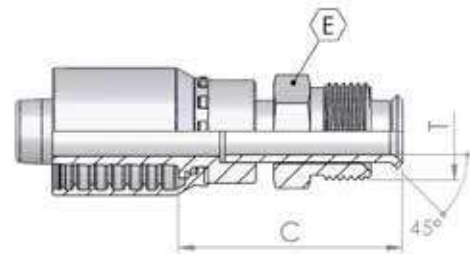

Part number	Hose I.D.		Dimension			
	in	mm	dash size	thread	hex	cut-off
				T	E	C
IF00G04-04	1/4	6.4	4	7/16-24	12	38
IF00G04-05	1/4	6.4	4	1/2-20	14	55
IF00G05-04	5/8	7.9	5	7/16-24	12	56
IF00G05-05	5/8	7.9	5	1/2-20	14	56
IF00G05-07	5/8	7.9	5	5/8-18	17	56
IF00G06-04	3/8	9.5	6	7/16-24	12	56
IF00G06-05	3/8	9.5	6	1/2-20	14	56
IF00G06-07	3/8	9.5	6	5/8-18	17	57
IF00G06-09	3/8	9.5	6	11/16-18	19	42
IF00G08-08	1/2	12.7	8	3/4-18	19	60

IF45G

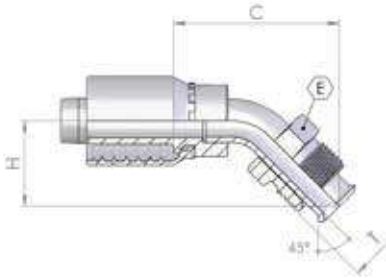

45° Male Inverted Flare Swivel

Part number	Hose I.D.		Dimension				
	in	mm	dash size	thread	hex	cut-off	Drop
				T	E	C	H
IF45G06-04	3/8	9.5	6	7/16-24	12	48	25
IF45G06-05	3/8	9.5	6	1/2-20	14	48	25
IF45G06-07	3/8	9.5	6	5/8-18	17	54	30
IF45G06-09	3/8	9.5	6	11/16-18	19	54	30
IF45G08-08	1/2	12.7	8	3/4-18			

IF90G

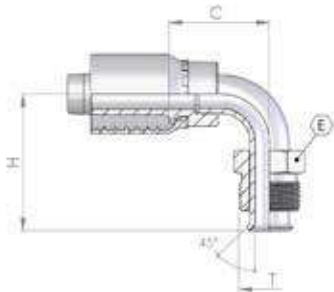

90° Male Inverted Flare Swivel

Part number	Hose I.D.		Dimension				
	in	mm	dash size	thread	hex	cut-off	Drop
				T	E	C	H
IF90G04-04	1/4	6.4	4	7/16-24	12	29	36
IF90G04-05	1/4	6.4	4	1/2-20	14	30	34
IF90G05-04	5/8	7.9	5	7/16-24	12	24	38
IF90G05-05	5/8	7.9	5	1/2-20	14	30	35
IF90G05-07	5/8	7.9	5	5/8-18	17	30	43
IF90G06-04	3/8	9.5	6	7/16-24	12	30	35
IF90G06-05	3/8	9.5	6	1/2-20	14	30	35
IF90G06-07	3/8	9.5	6	5/8-18	17	31	44
IF90G06-09	3/8	9.5	6	11/16-18	19	31	42
IF90G08-08	1/2	12.7	8	3/4-18	19	35	45

0930G

JIS Female 60° Cone (Toyota)

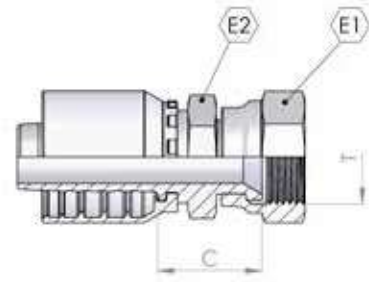

Part number	Hose I.D.		Dimension				
	in	mm	dash size	thread	hex		cut-off
				T	E	E1	C
0930G04-04	1/4	6.4	4	1/4-19	19	17	20
0930G06-06	3/8	9.5	6	3/8-19	22	19	22
0930G08-08	1/2	12.7	8	1/2-14	27	22	26
0930G12-12	3/4	19.0	12	3/4-14	32	30	29
0930G16-16	1	25.4	16	1-11	38	36	31
0930G20-20	1.1/4	31.8	20	1.1/4-11	50	46	35
0930G24-24	1.1/2	38.1	24	1.1/2-11	55	50	28

0980G

90° JIS Swept Elbow (Toyota) - welded

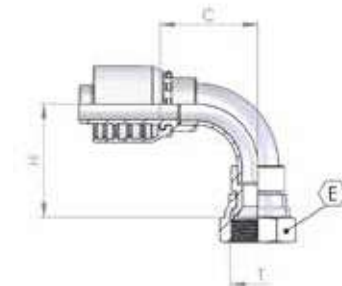

Part number	Hose I.D.		Dimension				
	in	mm	dash size	thread	hex	cut-off	Drop
				T	E	C	H
0980G04-04	1/4	6.4	4	1/4-19	19	38	35
0980G06-06	3/8	9.5	6	3/8-19	22	27	30
0980G08-08	1/2	12.7	8	1/2-14	27	33	39
0980G12-12	3/4	19.0	12	3/4-14	32	48	55
0980G16-16	1	25.4	16	1-11	38	57	62
0980G20-20	1.1/4	31.8	20	1.1/4-11	50	63	65
0980G24-24	1.1/2	38.1	24	1.1/2-11	55	80	83

0940G

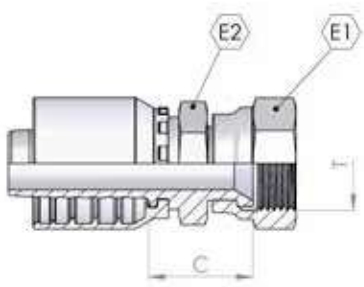

JIS Female 60° Cone (Komatsu)

Part number	Hose I.D.		Dimension				
	in	mm	dash size	thread	hex		cut-off
				T	E	E1	C
0940G04-14	1/4	6.4	4	M14x1.5	19	17	22
0940G05-16	5/16	7.9	5	M16x1.5	22	17	22
0940G06-14	3/8	9.5	6	M14x1.5	19	17	22
0940G06-18	3/8	9.5	6	M18x1.5	24	19	21
0940G08-22	1/2	12.7	8	M22x1.5	27	22	27
0940G10-24	5/8	15.9	10	M24x1.5	30	27	26
0940G12-30	3/4	19.0	12	M30x1.5	36	30	30
0940G16-33	1	25.4	16	M33x1.5	41	36	33
0940G20-36	1.1/4	31.8	20	M36x1.5	46	46	37
0940G24-42	1.1/2	38.1	24	M42x1.5	50	50	38

1040G

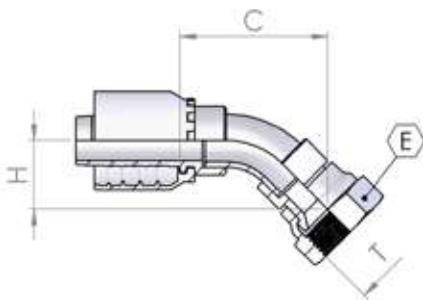

45° JIS Swept Elbow (Komatsu) - Welded

Part number	Hose I.D.		Dimension				
	in	mm	dash size	thread	hex	cut-off	Drop
				T	E	C	H
1040G-04-14	1/4	6.4	4	M14-1.5	19	44	18
1040G05-16	5/16	7.9	5	M16-1.5	22	38	18
1040G06-14	3/8	9.5	6	M14-1.5	19	41	18
1040G06-18	3/8	9.5	6	M18-1.5	24	43	18
1040G08-22	1/2	12.7	8	M22-1.5	27	40	20
1040G10-24	5/8	15.9	10	M24-1.5	30	50	26
1040G12-30	3/4	19.0	12	M30-1.5	36	56	26
1040G16-33	1	25.4	16	M33-1.5	41	65	33

0990G

90° JIS Swept Elbow (Komatsu) - Welded

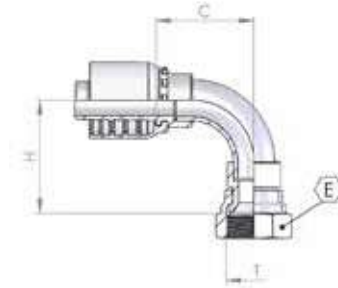

Part number	Hose I.D.		Dimension				
	in	mm	dash size	thread	hex	cut-off	Drop
				T	E	C	H
0990G04-14	1/4	6.4	4	M14x1.5	19	38	35
0990G05-16	5/16	7.9	5	M16x1.5	22	27	30
0990G06-14	3/8	9.5	6	M14x1.5	19	31	33
0990G06-18	3/8	9.5	6	M18x1.5	24	31	33
0990G08-22	1/2	12.7	8	M22x1.5	27	33	39
0990G10-24	5/8	15.9	10	M24x1.5	30	42	48
0990G12-30	3/4	19.0	12	M30x1.5	36	48	43
0990G16-33	1	25.4	16	M33x1.5	41	57	62

KO5BG

Kobelko Male

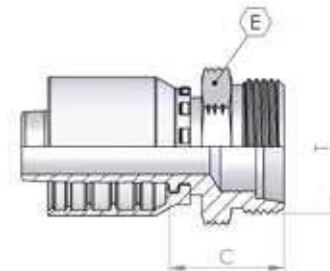

Part number	Hose I.D.		Dimension			
	in	mm	dash size	thread	hex	cut-off
				T	E	C
KO5BG10-30	5/8	15.9	10	M30-1.5	32	32
KO5BG12-30	3/4	19.0	12	M30-1.5	32	35
KO5BG12-36	3/4	19.0	12	M36-1.5	41	36
KO5BG16-36	1	25.4	16	M36-1.5	41	37
KO5BG16-45	1	25.4	16	M45-1.5	50	38

0360G

BSP Taper Male 60° Cone

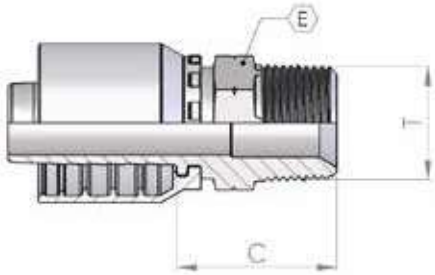

Part number	Hose I.D.		Dimension			
	in	mm	dash size	thread	hex	cut-off
				T	E	C
0360G03-02	3/16	4.8	3	1/8-28	12	21
0360G03-04	3/16	4.8	3	1/4-19	15	27
0360G04-02	1/4	6.4	4	1/8-28	12	22
0360G04-04	1/4	6.4	4	1/4-19	15	28
0360G04-06	1/4	6.4	4	3/8-19	19	28
0360G05-04	5/16	7.9	5	1/4-19	15	28
0360G05-06	5/16	7.9	5	3/8-19	19	28
0360G06-04	3/8	9.5	6	1/4-19	17	28
0360G06-06	3/8	9.5	6	3/8-19	19	28
0360G06-08	3/8	9.5	6	1/2-14	22	33
0360G08-06	1/2	12.7	8	3/8-19	19	29
0360G08-08	1/2	12.7	8	1/2-14	22	34
0360G08-12	1/2	12.7	8	3/4-14	27	36
0360G10-08	5/8	15.9	10	1/2-14	22	34
0360G10-10	5/8	15.9	10	5/8-14	24	35
0360G10-12	5/8	15.9	10	3/4-14	27	36
0360G12-12	3/4	19.0	12	3/4-14	27	37
0360G12-16	3/4	19.0	12	1-11	36	43
0360G16-16	1	25.4	16	1-11	36	44
0360G16-20	1	25.4	16	1.1/4-11	46	46
0360G20-20	1.1/4	31.8	20	1.1/4-11	46	47
0360G20-24	1.1/4	31.8	20	1.1/2-11	50	49
0360G24-24	1.1/2	38.1	24	1.1/2-11	50	49
0360G24-32	1.1/2	38.1	24	2-11	65	55
0360G32-32	2	50.8	32	2-11	65	55

0350G

BSP Male Parallel 60° Cone

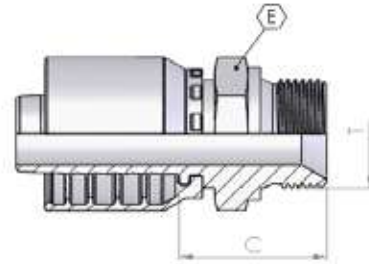

Part number	Hose I.D.		Dimension			
	in	mm	dash size	thread	hex	cut-off
				T	E	C
0350G03-02	3/16	4.8	3	1/8-28	14	21
0350G03-04	3/16	4.8	3	1/4-19	19	26
0350G04-02	1/4	6.4	4	1/8-28	14	21
0350G04-04	1/4	6.4	4	1/4-19	19	27
0350G04-06	1/4	6.4	4	3/8-19	22	28
0350G04-08	1/4	6.4	4	1/2-14	27	35
0350G05-04	5/16	7.9	5	1/4-19	19	27
0350G05-06	5/16	7.9	5	3/8-19	22	28
0350G05-08	5/16	7.9	5	1/2-14	27	32
0350G06-04	3/8	9.5	6	1/4-19	19	27
0350G06-06	3/8	9.5	6	3/8-19	22	29
0350G06-08	3/8	9.5	6	1/2-14	27	32
0350G08-06	1/2	12.7	8	3/8-19	22	29
0350G08-08	1/2	12.7	8	1/2-14	27	33
0350G08-10	1/2	12.7	8	5/8-14	30	34
0350G08-12	1/2	12.7	8	3/4-14	32	35
0350G10-08	5/8	15.9	10	1/2-14	27	33
0350G10-10	5/8	15.9	10	5/8-14	30	35
0350G10-12	5/8	15.9	10	3/4-14	32	35
0350G12-12	3/4	19.0	12	3/4-14	32	36
0350G12-16	3/4	19.0	12	1-11	41	39
0350G16-16	1	25.4	16	1-11	41	40
0350G16-20	1	25.4	16	1.1/4-11	50	44
0350G20-16	1.1/4	31.8	20	1-11	41	41
0350G20-20	1.1/4	31.8	20	1.1/4-11	50	45
0350G20-24	1.1/4	31.8	20	1.1/2-11	55	46
0350G24-24	1.1/2	38.1	24	1.1/2-11	55	46
0350G24-32	1.1/2	38.1	24	2-11	70	54
0350G32-24	2	50.8	32	1.1/2-11	65	50
0350G32-32	2	50.8	32	2-11	70	54

0051G

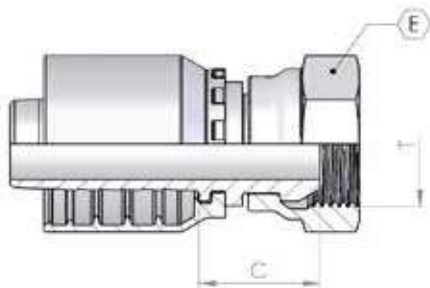

BSP Female 60° Cone - Rolled Nut

Part number	Hose I.D.		Dimension			
	in	mm	dash size	thread	hex	cut-off
				T	E	C
0051G03-02	3/16	4.8	3	1/8-28	14	15
0051G03-04	3/16	4.8	3	1/4-19	19	17
0051G04-02	1/4	6.4	4	1/8-28	14	15
0051G04-04	1/4	6.4	4	1/4-19	19	17
0051G04-06	1/4	6.4	4	3/8-19	22	19
0051G04-08	1/4	6.4	4	1/2-14	27	22
0051G05-04	5/16	7.9	5	1/4-19	19	17
0051G05-06	5/16	7.9	5	3/8-19	22	19
0051G05-08	5/16	7.9	5	1/2-14	27	22
0051G06-04	3/8	9.5	6	1/4-19	19	17
0051G06-06	3/8	9.5	6	3/8-19	22	19
0051G06-08	3/8	9.5	6	1/2-14	27	22
0051G08-06	1/2	12.7	8	3/8-19	22	20
0051G08-08	1/2	12.7	8	1/2-14	27	23
0051G08-10	1/2	12.7	8	5/8-14	30	20
0051G08-12	1/2	12.7	8	3/4-14	32	27
0051G10-08	5/8	15.9	10	1/2-14	27	23
0051G10-10	5/8	15.9	10	5/8-14	30	20
0051G10-12	5/8	15.9	10	3/4-14	32	25
0051G12-08	3/4	19	12	1/2-14	27	24
0051G12-12	3/4	19	12	3/4-14	32	25
0051G12-16	3/4	19	12	1-11	38	26
0051G16-12	1	25.4	16	3/4-14	32	27
0051G16-16	1	25.4	16	1-11	38	27

0050G

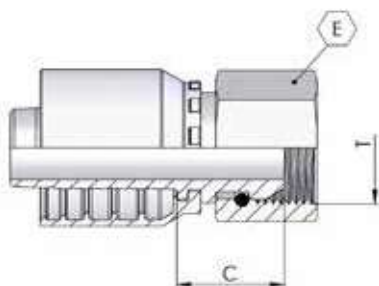

BSP Female 60° Cone - Thrust Wire Nut

Part number	Hose I.D.		Dimension			
	in	mm	dash size	thread	hex	cut-off
				T	E	C
0050G20-20	1.1/4	31.8	20	1.1/4-11	50	32
0050G24-24	1.1/2	38.1	24	1.1/2-11	55	34
0050G32-32	2	50.8	32	2-11	70	30

0251G

BSP 45° Swept Elbow 60° Cone - Rolled nut

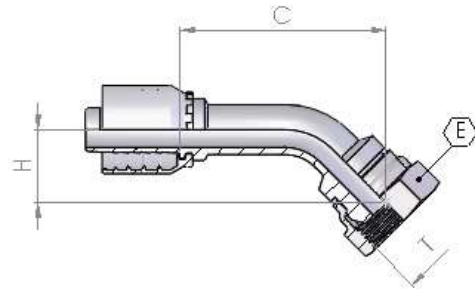

Part number	Hose I.D.		Dimension				
	in	mm	dash size	thread	hex	cut-off	Drop
				T	E	C	H
0251G03-02	3/16	4.8	3	1/8-28	14	33	15
0251G03-04	3/16	4.8	3	1/4-19	19	35	15
0251G04-02	1/4	6.4	4	1/8-28	14	40	14
0251G04-04	1/4	6.4	4	1/4-19	19	41	15
0251G05-04	5/16	7.9	5	1/4-19	19	47	16
0251G05-06	5/16	7.9	5	3/8-19	22	51	19
0251G06-04	3/8	9.5	6	1/4-19	19	50	16
0251G06-06	3/8	9.5	6	3/8-19	22	52	19
0251G06-08	3/8	9.5	6	1/2-14	27	55	21
0251G08-06	1/2	12.7	8	3/8-19	22	63	22
0251G08-08	1/2	12.7	8	1/2-12	27	65	24
0251G08-10	1/2	12.7	8	5/8-14	30	64	21
0251G08-12	1/2	12.7	8	3/4-14	32	67	26
0251G10-08	5/8	15.9	10	1/2-14	27	68	24
0251G10-10	5/8	15.9	10	5/8-14	30	68	23
0251G10-12	5/8	15.9	10	3/4-14	32	72	27
0251G12-12	3/4	19	12	3/4-14	32	86	30
0251G12-16	3/4	19	12	1-11	38	88	32
0251G16-16	1	25.4	16	1-11	38	107	35

0250G

BSP 45° Swept Elbow 60° Cone - Thrust Wire Nut

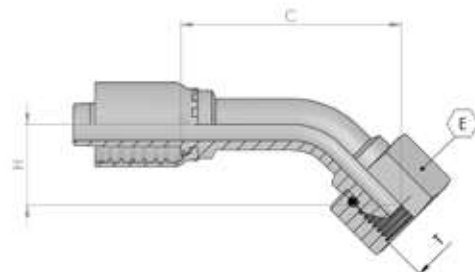

Part number	Hose I.D.		Dimension				
	in	mm	dash size	thread	hex	cut-off	Drop
				T	E	C	H
0250G20-20	1.1/4	31.8	20	1.1/4-11	50	107	40
0250G24-24	1.1/2	38.1	24	1.1/2-11	55	117	47
0250G32-32	2	50.8	32	2-11	70	142	65

0151G

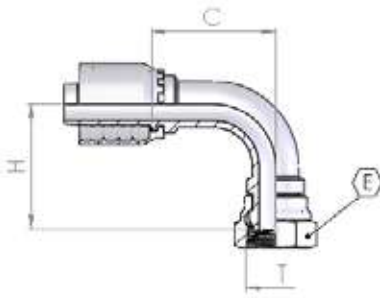

BSP 90° Swept elbow 60° Cone - Rolled Nut

Part number	Hose I.D.		Dimension				
	in	mm	dash size	thread	hex	cut-off	Drop
				T	E	C	H
0151G03-02	3/16	4.8	3	1/8-28	14	22	23
0151G03-04	3/16	4.8	3	1/4-19	19	22	25
0151G04-02	1/4	6.4	4	1/8-28	14	25	25
0151G04-04	1/4	6.4	4	1/4-19	19	25	27
0151G04-06	1/4	6.4	4	3/8-19	22	25	31
0151G05-04	5/16	7.9	5	1/4-19	19	31	31
0151G05-06	5/16	7.9	5	3/8-19	22	29	36
0151G06-04	3/8	9.5	6	1/4-19	19	31	33
0151G06-06	3/8	9.5	6	3/8-19	22	33	35
0151G06-08	3/8	9.5	6	1/2-14	27	31	40
0151G08-06	1/2	12.7	8	3/8-19	22	39	42
0151G08-08	1/2	12.7	8	1/2-14	27	39	41
0151G08-10	1/2	12.7	8	5/8-14	30	40	41
0151G08-12	1/2	12.7	8	3/4-14	32	41	46
0151G10-10	5/8	15.9	10	5/8-14	30	43	43
0151G10-12	5/8	15.9	10	3/4-14	32	45	50
0151G12-12	3/4	19	12	3/4-14	32	56	57
0151G12-16	3/4	19	12	1-11	38	56	60
0151G16-16	1	25.4	16	1-11	38	70	67

0150G

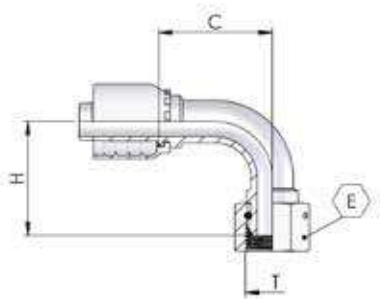

BSP 90° Swept Elbow 60° Cone - Thrust Wire Nut

Part number	Hose I.D.		Dimension				
	in	mm	dash size	thread	hex	cut-off	Drop
				T	E	C	H
0150G20-20	1.1/4	31.8	20	1.1/4-11	50	86	81
0150G24-24	1.1/2	38.1	24	1.1/2-11	55	103	95
0150G32-32	2	50.8	32	2-11	70	122	135

0041G

BSP O'Ring Female 60° Cone - Rolled Nut

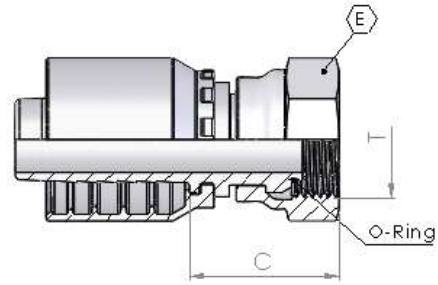

Part number	Hose I.D.		Dimension			
	in	mm	dash size	thread	hex	cut-off
				T	E	C
0041G04-04	1/4	6.4	4	1/4-19	19	17
0041G06-06	3/8	9.5	6	3/8-19	22	19
0041G08-08	1/2	12.7	8	1/2-14	27	21
0041G10-10	5/8	15.9	10	5/8-14	30	21
0041G12-12	3/4	19	12	3/4-14	32	26
0041G16-16	1	25.4	16	1-11	38	28

0241G

BSP O'Ring 45° Swept Elbow 60° Cone - Rolled nut

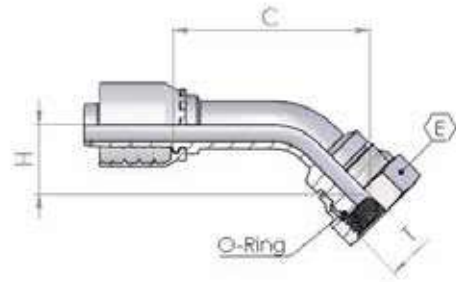

Part number	Hose I.D.		Dimension				
	in	mm	dash size	thread	hex	cut-off	Drop
				T	E	C	H
0241G04-04	1/4	6.4	4	1/4-19	19	41	15
0241G06-06	3/8	9.5	6	3/8-19	22	52	21
0241G08-08	1/2	12.7	8	1/2-14	27	63	22
0241G10-10	5/8	15.9	10	5/8-14	30	68	23
0241G12-12	3/4	19	12	3/4-14	32	88	28
0241G16-16	1	25.4	16	1-11	38	83	32

0141G

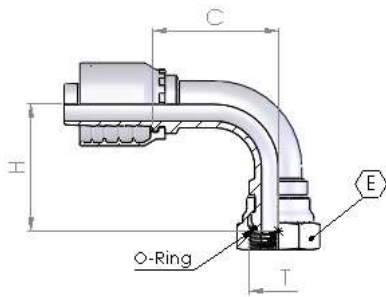

BSP O'Ring 90° Swept elbow 60° Cone - Rolled Nut

Part number	Hose I.D.		Dimension				
	in	mm	dash size	thread	hex	cut-off	Drop
				T	E	C	H
0141G04-04	1/4	6.4	4	1/4-19	19	25	27
0141G06-06	3/8	9.5	6	3/8-19	22	33	34
0141G08-08	1/2	12.7	8	1/2-14	27	41	40
0141G10-10	5/8	15.9	10	5/8-14	30	43	55
0141G12-12	3/4	19	12	3/4-14	32	56	54
0141G16-16	1	25.4	16	1-11	38	70	67

2321G

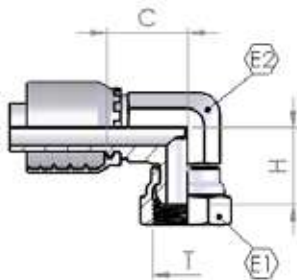

BSP 90° Compact Elbow 60° Cone - Rolled nut

Part number	Hose I.D.		Dimension					
	in	mm	dash size	thread	hex		cut-off	Drop
				T	E	E1	C	H
2321G04-04	1/4	6.4	4	1/4-19	19	15	19	20
2321G04-06	1/4	6.4	4	3/8-19	22	17	24	29
2321G05-06	5/16	7.9	5	3/8-19	22	17	24	23
2321G06-06	3/8	9.5	6	3/8-19	22	17	23	23
2321G06-08	3/8	9.5	6	1/2-14	27	19	28	26
2321G08-08	1/2	12.7	8	1/2-14	27	22	26	27
2321G12-12	3/4	19	12	3/4-14	32	27	32	32
2321G16-16	1	25.4	16	1-11	38	32	38	36

0060G

BSP Female Flat Seal

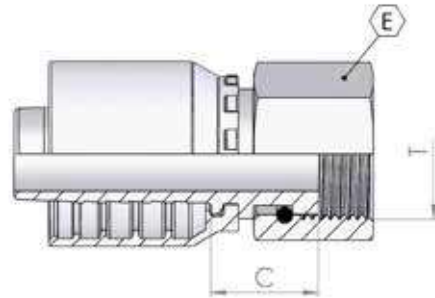

Part number	Hose I.D.		Dimension			
	in	mm	dash size	thread	hex	cut-off
				T	E	C
0060G04-04	1/4	6.4	4	1/4-19	19	14
0060G04-06	1/4	6.4	4	3/8-19	22	15
0060G05-04	5/16	7.9	5	1/4-19	19	14
0060G05-06	5/16	7.9	5	3/8-19	22	15
0060G05-08	5/16	7.9	5	1/2-14	27	17
0060G06-06	3/8	9.5	6	3/8-19	22	15
0060G06-08	3/8	9.5	6	1/2-14	27	16
0060G08-08	1/2	12.7	8	1/2-14	27	16
0060G08-10	1/2	12.7	8	5/8-14	30	16
0060G08-12	1/2	12.7	8	3/4-14	32	23
0060G10-10	5/8	15.9	10	5/8-14	30	16
0060G10-12	5/8	15.9	10	3/4-14	32	20
0060G12-12	3/4	19.0	12	3/4-14	32	21
0060G12-16	3/4	19.0	12	1-11	38	23
0060G16-16	1	25.4	16	1-11	38	22
0060G24-24	1.1/2	38.1	24	1.1/2-11	55	27

1400G

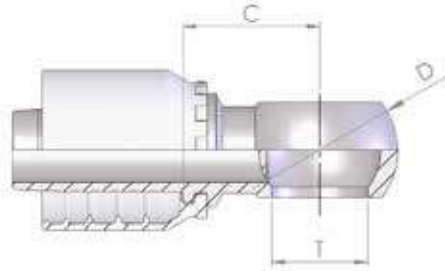

BSP Banjo

Part number	Hose I.D.		Dimension				
	in	mm	dash size	hole T	Flange mm	D Øball	cut-off C
1400G03-02	3/16	4.8	3	1/8-28	10.2	17	19
1400G03-04	3/16	4.8	3	1/4-19	13.3	24	26
1400G04-02	1/4	6.4	4	1/8-28	10.2	17	25
1400G04-04	1/4	6.4	4	1/4-19	13.3	24	26
1400G04-06	1/4	6.4	4	3/8-19	17	28	26
1400G05-04	5/16	7.9	5	1/4-19	13.3	24	26
1400G05-06	5/16	7.9	5	3/8-19	17	28	26
1400G06-04	3/8	9.5	6	1/4-19	13.3	24	26
1400G06-06	3/8	9.5	6	3/8-19	17	28	26
1400G06-08	3/8	9.5	6	1/2-14	21.2	36	31
1400G08-06	1/2	12.7	8	3/8-19	17	28	27
1400G08-08	1/2	12.7	8	1/2-14	21.2	36	31
1400G08-10	1/2	12.7	8	5/8-14	23.1	38	29
1400G08-12	1/2	12.7	8	3/4-14	26.5	45	38
1400G10-10	5/8	15.9	10	5/8-14	23.1	39	29
1400G10-12	5/8	15.9	10	3/4-14	26.5	45	38
1400G12-12	3/4	19.0	12	3/4-14	26.5	45	38
1400G12-16	3/4	19.0	12	1-11	33.5	58	49
1400G16-16	1	25.4	16	1-11	33.5	58	50

1600-00

BSP perfored bolt

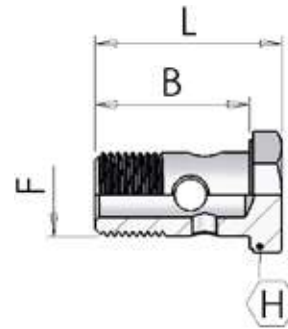

Part number	Dimension			
	F	B	L	Drop H
1600-00-02	1/8-28	19	24	14
1600-00-04	1/4-19	29	34	19
1600-00-06	3/8-19	33	41	22
1600-00-08	1/2-14	38	46	27
1600-00-10	5/8-14	44	54	30
1600-00-12	3/4-14	47	56	32
1600-00-16	1-11	58	69	41

1600

Double BSP perfored bolt

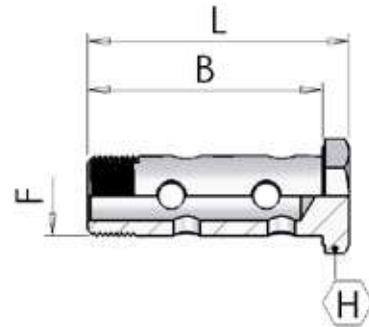

Part number	Dimension			
	F	B	L	Drop H
1600-04-04	1/4-19	43	49	19
1600-06-06	3/8-19	49	57	22
1600-08-08	1/2-14	62	70	27
1600-12-12	3/4-14	78	87	32
1600-16-16	1-11	98	109	41

FK50G

K' Female

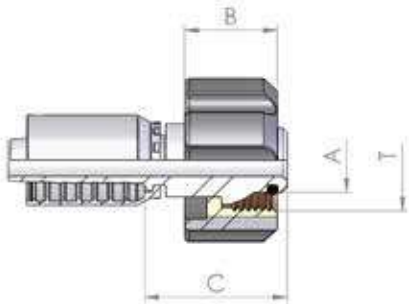

Part number	Hose I.D.		Dimension				
	in	mm	dash size	thread	cut-off		
				T	C	A	B
FK50G04-22	1/4	6.4	4	M22-1.5	31	14	20
FK50G05-22	5/16	7.9	5	M22-1.5	31	14	20
FK50G06-22	3/8	9.5	6	M22-1.5	31	14	20
FK50G04022	1/4	6.4	4	M22-1.5	31	14	27
FK50G05022	5/16	7.9	5	M22-1.5	31	14	27
FK50G06022	3/8	9.5	6	M22-1.5	31	14	27

0550G

Metric Standpipe

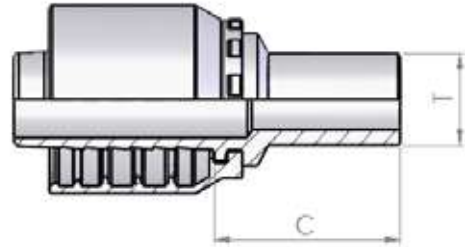

Part number	Hose I.D.		Dimension			
	in	mm	dash size	pipe	Type	cut-off
0550G03-06	3/16	4.8	3	6	L/S	30
0550G03-08	3/16	4.8	3	8	L/S	29
0550G04-06	1/4	6.4	4	6	L/S	32
0550G04-08	1/4	6.4	4	8	L/S	30
0550G04-10	1/4	6.4	4	10	L/S	33
0550G04-12	1/4	6.4	4	12	L/S	30
0550G05-08	5/16	7.9	5	08	L/S	31
0550G05-10	5/16	7.9	5	10	L/S	31
0550G05-12	5/16	7.9	5	12	L/S	33
0550G06-08	3/8	9.5	6	08	L/S	33
0550G06-10	3/8	9.5	6	10	L/S	33
0550G06-12	3/8	9.5	6	12	L/S	32
0550G06-14	3/8	9.5	6	14	S	37
0550G06-15	3/8	9.5	6	15	L	32
0550G08-12	1/2	12.7	8	12	L/S	36
0550G08-14	1/2	12.7	8	14	S	39
0550G08-15	1/2	12.7	8	15	L	34
0550G08-16	1/2	12.7	8	16	S	39
0550G08-18	1/2	12.7	8	18	L	35
0550G08-20	1/2	12.7	8	20	S	45
0550G10-18	5/8	15.9	10	18	L	35
0550G10-20	5/8	15.9	10	20	S	45
0550G10-22	5/8	15.9	10	22	L	33
0550G12-18	3/4	19.0	12	18	L	37
0550G12-20	3/4	19.0	12	20	S	46
0550G12-22	3/4	19.0	12	22	L	38
0550G12-25	3/4	19.0	12	25	S	49
0550G12-28	3/4	19.0	12	28	L	40
0550G16-25	1	25.4	16	25	S	51
0550G16-28	1	25.4	16	28	L	41
0550G16-30	1	25.4	16	30	S	54
0550G16-38	1	25.4	16	38	S	60
0550G20-30	1.1/4	31.8	20	30	S	58
0550G20-35	1.1/4	31.8	20	35	L	48
0550G20-38	1.1/4	31.8	20	38	S	62
0550G24-38	1.1/2	38.1	24	38	S	63
0550G24-42	1.1/2	38.1	24	42	L	50

0750G

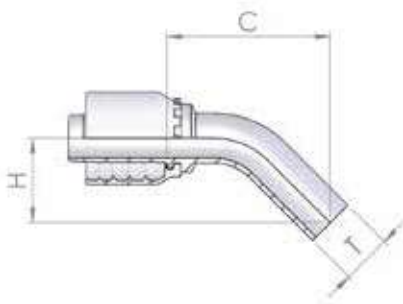

45° Metric Standpipe

Part number	Hose I.D.		Dimension				
	in	mm	dash size	pipe	Type	cut-off	Drop
				T		C	H
0750G04-06	1/4	6.4	4	6	L/S	41	24
0750G04-08	1/4	6.4	4	8	L/S	43	25
0750G04-10	1/4	6.4	4	10	L/S	47	30
0750G05-10	5/16	7.9	5	10	L/S	49	30
0750G05-12	5/16	7.9	5	12	L/S	53	32
0750G06-12	3/8	9.5	6	12	L/S	52	33

0750G

45° Metric Standpipe (Welded)

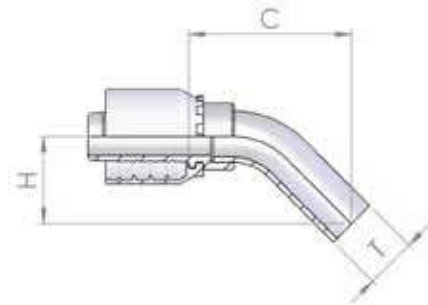

Part number	Hose I.D.		Dimension				
	in	mm	dash size	pipe	Type	cut-off	Drop
				T		C	H
0750G04-12	1/4	6.4	4	12	L/S	54	29
0750G06-14	3/8	9.5	6	14	S	50	27
0750G06-15	3/8	9.5	6	15	L	54	29
0750G08-14	1/2	12.7	8	14	S	50	27
0750G08-15	1/2	12.7	8	15	L	55	29
0750G08-16	1/2	12.7	8	16	S	54	27
0750G08-18	1/2	12.7	8	18	L	56	29
0750G10-18	5/8	15.9	10	18	L	56	29
0750G10-20	5/8	15.9	10	20	S	56	34
0750G10-22	5/8	15.9	10	22	L	66	35
0750G12-20	3/4	19.0	12	20	S	63	34
0750G12-22	3/4	19.0	12	22	L	65	35
0750G12-25	3/4	19.0	12	25	S	76	41
0750G16-25	1	25.4	16	25	S	76	41
0750G16-28	1	25.4	16	28	L	84	49
0750G16-30	1	25.4	16	30	S	86	44
0750G20-30	1.1/4	31.8	20	30	S	88	44
0750G20-35	1.1/4	31.8	20	35	L	94	47
0750G20-38	1.1/4	31.8	20	38	S	101	50
0750G24-38	1.1/2	38.1	24	38	S	100	50
0750G24-42	1.1/2	38.1	24	42	L	114	55

0650G

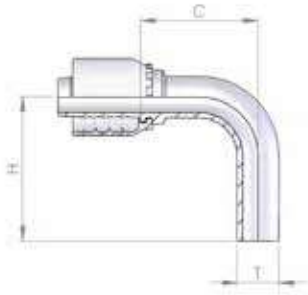

90° Metric Standpipe

Part number	Hose I.D.		Dimension				
	in	mm	dash size	pipe	Type	cut-off	Drop
				T		C	H
0650G03-06	3/16	4.8	3	6	L/S	20	32
0650G04-06	1/4	6.4	4	6	L/S	23	32
0650G04-08	1/4	6.4	4	8	L/S	25	34
0650G04-10	1/4	6.4	4	10	L/S	25	43
0650G05-10	5/16	7.9	5	10	L/S	29	40
0650G05-12	5/16	7.9	5	12	L/S	29	45
0650G06-10	3/8	9.5	6	10	L/S	27	40
0650G06-12	3/8	9.5	6	12	L/S	30	44

0650G

90° Metric Standpipe (welded)

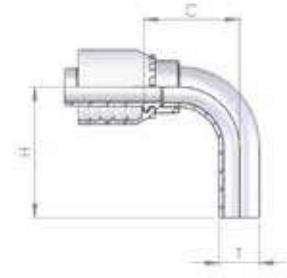

Part number	Hose I.D.		Dimension				
	in	mm	dash size	pipe	Type	cut-off	Drop
				T		C	H
0650G06-15	3/8	9.5	6	15	L	39	52
0650G03-08	3/16	4.8	3	8	L/S	25	41
0650G04-12	1/4	6.4	4	12	L/S	35	44
0650G05-08	5/16	7.9	5	8	L/S	27	41
0650G06-14	3/8	9.5	6	14	S	36	46
0650G08-12	1/2	12.7	8	12	L/S	33	44
0650G08-14	1/2	12.7	8	14	S	36	46
0650G08-15	1/2	12.7	8	15	L	39	52
0650G08-16	1/2	12.7	8	16	S	42	56
0650G08-18	1/2	12.7	8	18	L	42	56
0650G10-18	5/8	15.9	10	18	L	42	56
0650G10-20	5/8	15.9	10	20	S	48	65
0650G10-22	5/8	15.9	10	22	L	51	71
0650G12-20	3/4	19.0	12	20	S	48	65
0650G12-22	3/4	19.0	12	22	L	51	71
0650G12-25	3/4	19.0	12	25	S	57	75
0650G16-25	1	25.4	16	25	S	57	75
0650G16-28	1	25.4	16	28	L	60	89
0650G16-30	1	25.4	16	30	S	65	89
0650G20-30	1.1/4	31.8	20	30	S	66	89
0650G20-35	1.1/4	31.8	20	35	L	76	98
0650G20-38	1.1/4	31.8	20	38	S	83	102
0650G24-38	1.1/2	38.1	24	38	S	82	102
0650G24-42	1.1/2	38.1	24	42	L	106	125

1350G

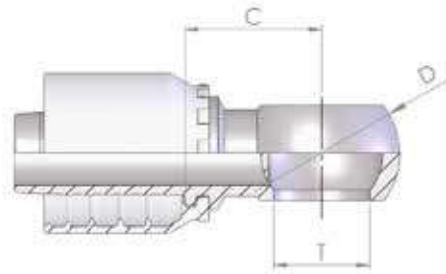

Metric Banjo

Part number	Hose I.D.		Dimension				
	in	mm	dash size	hole T	Flange mm	D Øball	cut-off C
1350G03-10	3/16	4.8	3	M10-1	10.2	17	25
1350G03-12	3/16	4.8	3	M12-1.5	12.2	20	21
1350G04-10	1/4	6.4	4	M10-1	10.2	17	25
1350G04-12	1/4	6.4	4	M12-1.5	12.2	20	22
1350G04-14	1/4	6.4	4	M14-1.5	14.2	24	25
1350G05-14	5/16	7.9	5	M14-1.5	14.2	24	25
1350G05-16	5/16	7.9	5	M16-1.5	16.2	28	31
1350G05-18	5/16	7.9	5	M18-1.5	18.2	32	29
1350G06-14	3/8	9.5	6	M14-1.5	14.2	24	25
1350G06-16	3/8	9.5	6	M16-1.5	16.2	28	31
1350G06-18	3/8	9.5	6	M18-1.5	18.2	32	29
1350G06-22	3/8	9.5	6	M22-1.5	22.2	36	31
1350G08-16	1/2	12.7	8	M16-1.5	16.2	28	30
1350G08-18	1/2	12.7	8	M18-1.5	18.2	32	29
1350G08-22	1/2	12.7	8	M22-1.5	22.2	36	31
1350G10-22	5/8	15.9	10	M22-1.5	22.2	36	31
1350G10-26	5/8	15.9	10	M26-1.5	26.2	45	38
1350G12-22	3/4	19.0	12	M22-1.5	22.2	36	32

1650

Metric perfored bolt

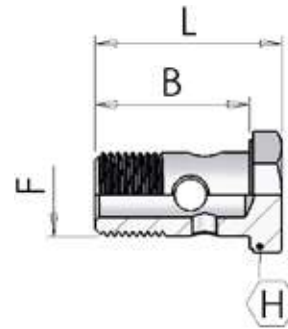

Part number	Dimension			
	F	B	L	Drop H
1650-00-10	M10-1	19	24	14
1650-00-12	M12-1.5	26	31	17
1650-00-14	M14-1.5	29	34	19
1650-00-16	M16-1.5	33	41	22
1650-00-18	M18-1.5	37	44	24
1650-00-20	M20-1.5	38	46	27
1650-00-22	M22-1.5	38	46	27
1650-00-26	M26-1.5	47	56	32
1650-00-30	M30-1.5	58	68	36

0500G

Metric Male 24° - Seat Light

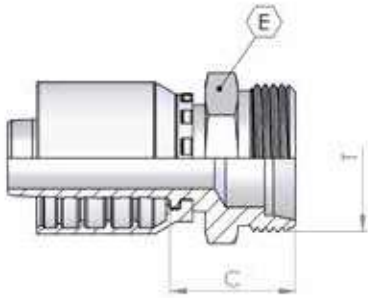

Part number	Hose I.D.		Dimension				
	in	mm	dash size	thread	erm	hex	cut-off
				T		E	C
0500G03-12	3/16	4.8	3	M12-1.5	6	14	22
0500G04-12	1/4	6.4	4	M12-1.5	6	14	23
0500G04-14	1/4	6.4	4	M14-1.5	8	14	22
0500G04-16	1/4	6.4	4	M16-1.5	10	17	23
0500G04-18	1/4	6.4	4	M18-1.5	12	19	24
0500G05-14	5/16	7.9	5	M14-1.5	8	14	22
0500G05-16	5/16	7.9	5	M16-1.5	10	17	23
0500G05-18	5/16	7.9	5	M18-1.5	12	19	24
0500G05-22	5/16	7.9	5	M22-1.5	15	22	25
0500G06-16	3/8	9.5	6	M16-1.5	10	17	23
0500G06-18	3/8	9.5	6	M18-1.5	12	19	24
0500G06-22	3/8	9.5	6	M22-1.5	15	22	25
0500G08-18	1/2	12.7	8	M18-1.5	12	19	25
0500G08-22	1/2	12.7	8	M22-1.5	15	22	26
0500G08-26	1/2	12.7	8	M26-1.5	18	27	27
0500G10-22	5/8	15.9	10	M22-1.5	15	22	26
0500G10-26	5/8	15.9	10	M26-1.5	18	27	27
0500G10-30	5/8	15.9	10	M30-2	22	30	32
0500G12-26	3/4	19.0	12	M26-1.5	18	27	28
0500G12-30	3/4	19.0	12	M30-2	22	30	33
0500G16-36	1	25.4	16	M36-2	28	36	32
0500G20-45	1.1/4	31.8	20	M45-2	35	46	36
0500G24-52	1.1/2	38.1	24	M52-2	42	55	38

0085G

Metric Female 24° - Seat Light

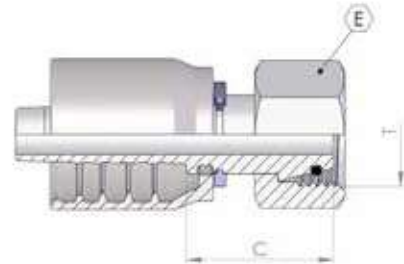

Part number	Hose I.D.		Dimension				
	in	mm	dash size	thread	erm	hex	cut-off
				T		E	C
0085G03-12	3/16	4.8	3	M12-1.5	6	14	23
0085G04-14	1/4	6.4	4	M14-1.5	8	17	24
0085G04-16	1/4	6.4	4	M16-1.5	10	19	24
0085G04-18	1/4	6.4	4	M18-1.5	12	22	25
0085G05-16	5/16	7.9	5	M16-1.5	10	19	24
0085G05-18	5/16	7.9	5	M18-1.5	12	22	25
0085G06-18	3/8	9.5	6	M18-1.5	12	22	25
0085G06-22	3/8	9.5	6	M22-1.5	15	27	29
0085G08-22	1/2	12.7	8	M22-1.5	15	27	29
0085G08-26	1/2	12.7	8	M26-1.5	18	32	29
0085G10-26	5/8	15.9	10	M26-1.5	18	32	29
0085G10-30	5/8	15.9	12	M30-2	22	36	29
0085G12-30	3/4	19.0	12	M30-2	22	36	29
0085G12-36	3/4	19.0	12	M36-2	28	41	28
0085G16-36	1	25.4	16	M36-2	28	41	30
0085G20-45	1.1/4	31.8	20	M45-2	35	50	40
0085G24-52	1.1/2	38.1	24	M52-2	42	60	41

0085G

Metric Female 24° - Seat Light (rolled nut)

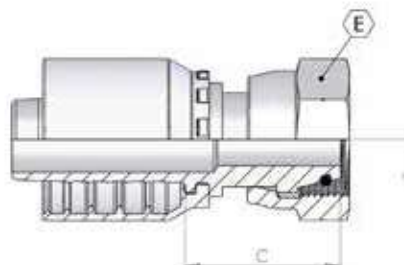

Part number	Hose I.D.		Dimension				
	in	mm	dash size	thread	erm	hex	cut-off
				T		E	C
0085G-04-12	1/4	6.4	4	M12-1.5	6	14	25
0085G-05-14	5/16	7.9	5	M14-1.5	8	19	26
0085G-06-16	3/8	9.5	6	M16-1.5	10	19	25
0085G-08-18	1/2	12.7	8	M18-1.5	12	24	28
0085G-10-22	5/8	15.9	10	M22-1.5	15	27	32
0085G-12-26	3/4	19.0	12	M26-1.5	18	32	36

0285G

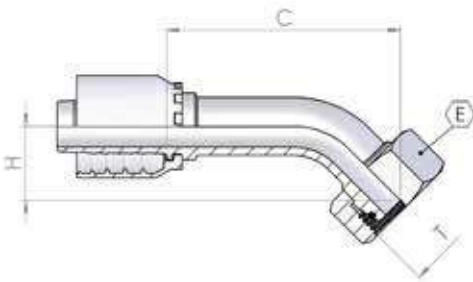

45° Metric Swept Elbow 24° - Seat Light

Part number	Hose I.D.		Dimension					
	in	mm	dash size	thread	erm	hex	cut-off	Drop
				T		E	C	H
0285G03-12	3/16	4.8	3	M12-1.5	6	14	36	14
0285G04-14	1/4	6.4	4	M14-1.5	8	17	42	14
0285G04-16	1/4	6.4	4	M16-1.5	10	19	42	15
0285G04-18	1/4	6.4	4	M18-1.5	12	22	43	16
0285G05-16	5/16	7.9	5	M16-1.5	10	19	48	17
0285G05-18	5/16	7.9	5	M18-1.5	12	22	48	18
0285G06-18	3/8	9.5	6	M18-1.5	12	22	52	19
0285G06-22	3/8	9.5	6	M22-1.5	15	27	51	19
0285G08-22	1/2	12.7	8	M22-1.5	15	27	63	21
0285G08-26	1/2	12.7	8	M26-1.5	18	32	44	17
0285G10-26	5/8	15.9	10	M26-1.5	18	32	68	23
0285G12-26	3/4	19.0	12	M26-1.5	18	32	43	19
0285G12-30	3/4	19.0	12	M30-2	22	36	85	27
0285G16-36	1	25.4	16	M36-2	28	41	102	32
0285G20-45	1.1/4	31.8	20	M45-2	35	50	72	34
0285G24-52	1.1/2	38.1	24	M52-2	42	60	85	36

0285G

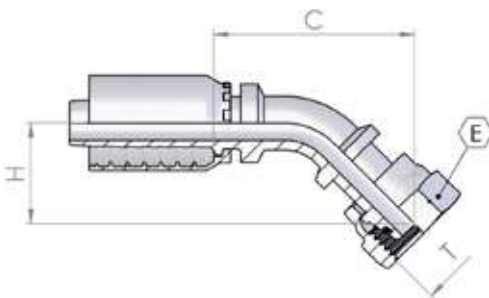

45° Metric Swept Elbow 24° - Seat Light (rolled nut)

Part number	Hose I.D.		Dimension					
	in	mm	dash size	thread	erm	hex	cut-off	Drop
				T		E	C	H
0285G04-12	1/4	6.4	4	M12-1.5	6	14	46	20
0285G06-16	3/8	9.5	6	M16-1.5	10	19	55	22

0185G

90° Metric Swept Elbow 24° - Seat Light

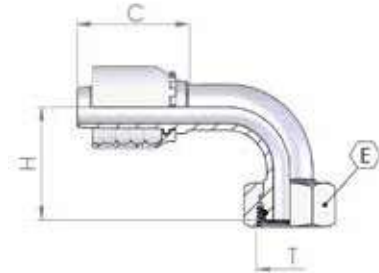

Part number	Hose I.D.		Dimension					
	in	mm	dash size	thread	erm	hex	cut-off	Drop
				T		E	C	H
0185G03-12	3/16	4.8	3	M12-1.5	6	14	22	23
0185G04-14	1/4	6.4	4	M14-1.5	8	17	26	26
0185G04-16	1/4	6.4	4	M16-1.5	10	19	25	27
0185G04-18	1/4	6.4	4	M18-1.5	12	22	27	30
0185G05-16	5/16	7.9	5	M16-1.5	10	19	31	31
0185G05-18	5/16	7.9	5	M18-1.5	12	22	31	32
0185G06-18	3/8	9.5	6	M18-1.5	12	22	32	35
0185G06-22	3/8	9.5	6	M22-1.5	15	27	32	35
0185G08-22	1/2	12.7	8	M22-1.5	15	27	41	38
0185G08-26	1/2	12.7	8	M26-1.5	18	32	41	39
0185G10-26	5/8	15.9	10	M26-1.5	18	32	44	44
0185G12-26	3/4	19.0	12	M26-1.5	18	32	42	44
0185G12-30	3/4	19.0	12	M30-2	22	36	58	52
0185G12-36	3/4	19.0	12	M36-2	28	41	49	51
0185G16-36	1	25.4	16	M36-2	28	41	72	62
0185G20-45	1.1/4	31.8	20	M45-2	35	50	63	73
0185G24-52	1.1/2	38.1	24	M52-2	42	60	81	83

0185G

90° Metric Swept Elbow 24° - Seat Light (rolled nut)

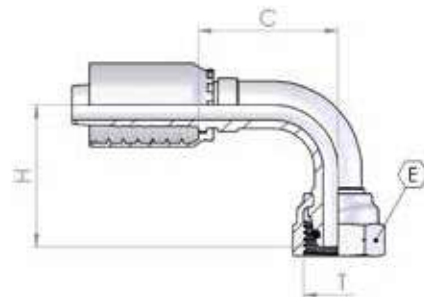

Part number	Hose I.D.		Dimension					
	in	mm	dash size	thread	erm	hex	cut-off	Drop
				T		E	C	H
0185G04-12	1/4	6.4	4	M12-1.5	6	14	26	34
0185G05-14	5/16	7.9	5	M14-1.5	8	17	30	38
0185G06-16	3/8	9.5	6	M16-1.5	10	19	32	39
0185G08-18	1/2	12.7	8	M18-1.5	12	22	33	48
0185G10-22	5/8	15.9	8	M22-1.5	15	27	42	55

0450G

Metric Male 24° - Seat Heavy

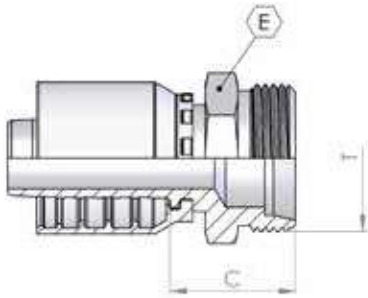

Part number	Hose I.D.		Dimension				
	in	mm	dash size	thread	erm	hex	cut-off
				T		E	C
0450G03-16	3/16	4.8	3	M16-1.5	8	17	26
0450G04-14	1/4	6.4	4	M14-1.5	6	14	25
0450G04-16	1/4	6.4	4	M16-1.5	8	17	27
0450G04-18	1/4	6.4	4	M18-1.5	10	19	27
0450G05-18	5/16	7.9	5	M18-1.5	10	19	27
0450G05-20	5/16	7.9	5	M20-1.5	12	22	29
0450G06-18	3/8	9.5	6	M18-1.5	10	19	27
0450G06-20	3/8	9.5	6	M20-1.5	12	22	29
0450G06-22	3/8	9.5	6	M22-1.5	14	22	31
0450G06-24	3/8	9.5	6	M24-1.5	16	24	31
0450G08-24	1/2	12.7	8	M24-1.5	16	24	32
0450G10-30	5/8	15.9	10	M30-2	20	30	34
0450G12-30	3/4	19.0	12	M30-2	20	30	35
0450G12-36	3/4	19.0	12	M36-2	25	36	38
0450G16-36	1	25.4	16	M36-2	25	36	39
0450G16-42	1	25.4	16	M42-2	30	46	42
0450G20-42	1.1/4	31.8	20	M42-2	30	46	43
0450G20-52	1.1/4	31.8	20	M52-2	38	55	45
0450G24-52	1.1/2	38.1	24	M52-2	38	55	45

0084G

Metric Female 24° - Seat Heavy

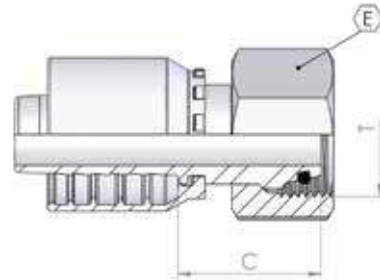

Part number	Hose I.D.		Dimension				
	in	mm	dash size	thread	erm	hex	cut-off
				T		E	C
0084G03-16	3/16	4.8	3	M16-1.5	8	19	25
0084G04-14	1/4	6.4	4	M14-1.5	6	17	23
0084G04-16	1/4	6.4	4	M16-1.5	8	19	25
0084G04-18	1/4	6.4	4	M18-1.5	10	22	24
0084G05-18	5/16	7.9	5	M18-1.5	10	22	24
0084G05-20	5/16	7.9	5	M20-1.5	12	24	26
0084G06-16	3/8	9.5	6	M16-1.5	8	19	26
0084G06-18	3/8	9.5	6	M18-1.5	10	22	25
0084G06-20	3/8	9.5	6	M20-1.5	12	24	25
0084G06-22	3/8	9.5	6	M22-1.5	14	27	29
0084G08-22	1/2	12.7	8	M22-1.5	14	27	17
0084G08-24	1/2	12.7	8	M24-1.5	16	30	30
0084G08-30	1/2	12.7	8	M30-2	20	36	33
0084G10-24	5/8	15.9	10	M24-1.5	16	30	31
0084G10-30	5/8	15.9	10	M30-2	20	36	33
0084G12-30	3/4	19.0	12	M30-2	20	36	34
0084G12-36	3/4	19.0	12	M36-2	25	46	40
0084G16-36	1	25.4	16	M36-2	25	46	41
0084G16-42	1	25.4	16	M42-2	30	50	43
0084G20-52	1.1/4	31.8	20	M52-2	38	60	44
0084G24-52	1.1/2	38.1	24	M52-2	38	60	44

0284G

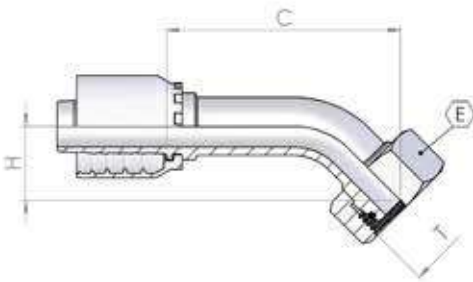

45° Metric Swept Elbow 24° - Seat Heavy

Part number	Hose I.D.		Dimension					
	in	mm	dash size	thread	erm	hex	cut-off	Drop
				T		E	C	H
0284G03-16	3/16	4.8	3	M16-1.5	8	19	36	16
0284G04-14	1/4	6.4	4	M14-1.5	6	17	37	15
0284G04-16	1/4	6.4	4	M16-1.5	8	19	42	15
0284G04-18	1/4	6.4	4	M18-1.5	10	22	45	18
0284G05-20	5/16	7.9	5	M20-1.5	12	24	49	19
0284G06-18	3/8	9.5	6	M18-1.5	10	22	51	19
0284G06-20	3/8	9.5	6	M20-1.5	12	24	53	18
0284G06-22	3/8	9.5	6	M22-1.5	14	27	54	20
0284G08-24	1/2	12.7	8	M24-1.5	16	30	63	21
0284G10-30	5/8	15.9	10	M30-2	20	36	74	29
0284G12-30	3/4	19.0	12	M30-2	20	36	87	30
0284G12-36	3/4	19.0	12	M36-2	25	46	56	31
0284G16-36	1	25.4	16	M36-2	25	46	105	34
0284G16-42	1	25.4	16	M42-2	30	50	82	33
0284G20-52	1.1/4	31.8	20	M52-2	38	60	105	39
0284G24-52	1.1/2	38.1	24	M52-2	38	60	157	52

0184G

90° Metric Swept Elbow 24° - Seat Heavy

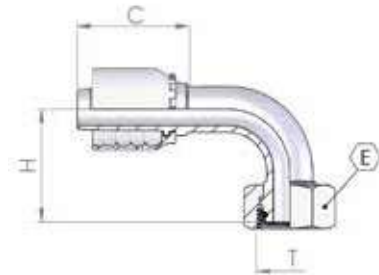

Part number	Hose I.D.		Dimension					
	in	mm	dash size	thread	erm	hex	cut-off	Drop
				T		E	C	H
0184G03-16	3/16	4.8	3	M16-1.5	8	19	22	25
0184G04-14	1/4	6.4	4	M14-1.5	6	17	27	26
0184G04-16	1/4	6.4	4	M16-1.5	8	19	26	26
0184G04-18	1/4	6.4	4	M18-1.5	10	22	27	31
0184G04-20	1/4	6.4	4	M20-1.5	12	24	27	30
0184G05-18	5/16	7.9	5	M18-1.5	10	22	33	33
0184G05-20	5/16	7.9	5	M20-1.5	12	24	30	34
0184G06-18	3/8	9.5	6	M18-1.5	10	22	34	35
0184G06-20	3/8	9.5	6	M20-1.5	12	24	34	34
0184G06-22	3/8	9.5	6	M22-1.5	14	27	33	33
0184G08-24	1/2	12.7	8	M24-1.5	16	30	40	41
0184G10-24	5/8	15.9	10	M24-1.5	16	30	42	60
0184G10-30	5/8	15.9	10	M30-2	20	36	46	50
0184G12-30	3/4	19.0	12	M30-2	20	36	58	56
0184G12-36	3/4	19.0	12	M36-2	25	46	56	59
0184G16-36	1	25.4	16	M36-2	25	46	69	67
0184G16-42	1	25.4	16	M42-2	30	50	69	67
0184G20-52	1.1/4	31.8	20	M52-2	38	60	84	82
0184G24-52	1.1/2	38.1	24	M52-2	38	60	99	94

1260G

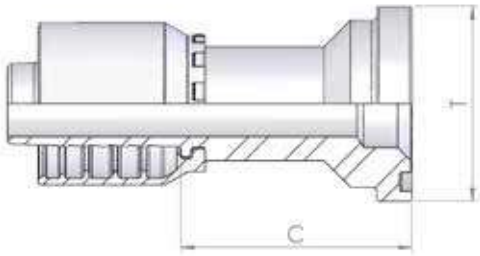

Straight SAE Flange 3000 PSI

Part number	Hose I.D.		Dimension		
	in	mm	dash size	Flange mm	cut-off C
1260G08-08	1/2	12.7	8	30,2	45
1260G08-12	1/2	12.7	8	38.1	50
1260G10-08	5/8	15.9	10	30,2	45
1260G10-12	5/8	15.9	10	38.1	49
1260G12-12	3/4	19	12	38.1	50
1260G12-16	3/4	19	12	44.5	53
1260G16-16	1	25.4	16	44.5	54
1260G16-20	1	25.4	16	50.8	57
1260G20-20	1.1/4	31.8	20	50.8	59
1260G20-24	1.1/4	31.8	20	60.3	62
1260G24-24	1.1/2	38.1	24	60.3	62
1260G24-32	1.1/2	38.1	24	71.4	67
1260G32-32	2	50.8	32	71.4	68
1260G32-40	2	50.8	32	84.1	76

1160G

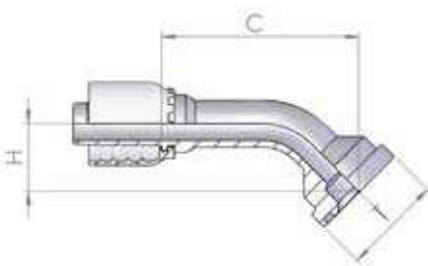

45° SAE Flange 3000 PSI

Part number	Hose I.D.		Dimension			
	in	mm	dash size	Flange mm	cut-off C	Drop H
1160G08-08	1/2	12.7	8	30.2	62	22
1160G08-12	1/2	12.7	8	38.1	67	25
1160G12-12	3/4	19	12	38.1	69	27
1160G12-16	3/4	19	12	44.5	88	30
1160G16-16	1	25.4	16	44.5	82	33
1160G20-20	1.1/4	31.8	20	50.8	102	38
1160G20-24	1.1/4	31.8	20	60.3	129	39
1160G24-24	1.1/2	38.1	24	60.3	114	44
1160G24-32	1.1/2	38.1	24	71.4	148	47
1160G32-32	2	50.8	32	71.4	130	58

1060G

90° SAE Flange 3000 PSI

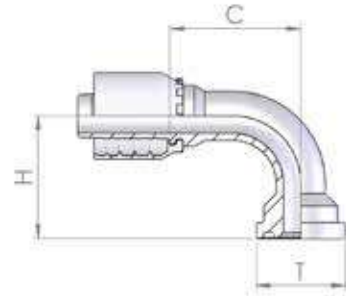

Part number	Hose I.D.		Dimension			
	in	mm	dash size	Flange mm	cut-off C	Drop H
1060G08-08	1/2	12.7	8	30,2	39	39
1060G08-12	1/2	12.7	8	38.1	39	44
1060G10-08	5/8	15.9	10	30,2	45	42
1060G10-12	5/8	15.9	10	38.1	45	47
1060G12-12	3/4	19	12	38.1	56	53
1060G12-16	3/4	19	12	44.5	56	58
1060G16-16	1	25.4	16	44.5	70	65
1060G16-20	1	25.4	16	50.8	70	70
1060G16-24	1	25.4	16	60.3	72	71
1060G20-16	1.1/4	31.8	20	44.5	81	77
1060G20-20	1.1/4	31.8	20	50.8	86	77
1060G20-24	1.1/4	31.8	20	60.3	85	81
1060G24-24	1.1/2	38.1	24	60.3	98	89
1060G24-32	1.1/2	38.1	24	71.4	93	97
1060G32-32	2	50.8	32	71.4	123	121

1060G

22.5°/30°/60°/67.5° SAE Flange 3000 PSI

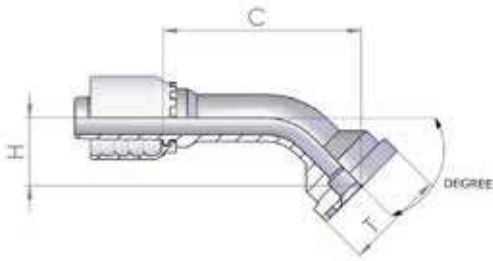

Part number	Hose I.D.		dash size	Dimension			Degree
	in	mm		Flange	cut-off	Drop	
				mm	C	H	
1060G12-12 22.5	3/4	19	12	38.1	76	11	22.5°
1060G16-16 22.5	1	25.4	16	44.5	89	14	22.5°
1060G20-20 22.5	1.1/4	31.8	20	50.8	111	14	22.5°
1060G24-24 22.5	1.1/2	38.1	24	60.3	124	17	22.5°
1060G32-32 22.5	2	50.8	32	71.4	144	28	22.5°
1060G12-12 30	3/4	19	12	38.1	75	16	30°
1060G16-16 30	1	25.4	16	44.5	87	19	30°
1060G20-20 30	1.1/4	31.8	20	50.8	109	26	30°
1060G24-24 30	1.1/2	38.1	24	60.3	122	23	30°
1060G32-32 30	2	50.8	32	71.4	142	35	30°
1060G12-12 60	3/4	19	12	38.1	76	36	60°
1060G16-16 60	1	25.4	16	44.5	95	43	60°
1060G20-20 60	1.1/4	31.8	20	50.8	116	49	60°
1060G24-24 60	1.1/2	38.1	24	60.3	138	55	60°
1060G32-32 60	2	50.8	32	71.4	170	80	60°
1060G12-12 67.5	3/4	19	12	38.1	72	41	67.5°
1060G16-16 67.5	1	25.4	16	44.5	91	48	67.5°
1060G20-20 67.5	1.1/4	31.8	20	50.8	110	56	67.5°
1060G24-24 67.5	1.1/2	38.1	24	60.3	131	63	67.5°
1060G32-32 67.5	2	50.8	32	71.4	158	92	67.5°

D050G

Hose Junction

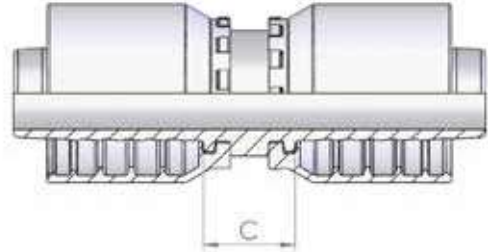

Part number	Hose I.D.		Dimension	
	in	mm	dash size	cut-off C
D050G03	3/16	4.8	3	17
D050G04	1/4	6.4	4	17
D050G05	5/16	7.9	5	17
D050G06	3/8	9.5	6	17
D050G08	1/2	12.7	8	18
D050G10	5/8	15.9	10	18
D050G12	3/4	19.0	12	19
D050G16	1	25.4	16	21
D050G20	1.1/4	31.8	20	24
D050G24	1.1/2	38.1	24	24
D050G32	2	50.8	32	26